

Agilent 34934A High Density Matrix Module

User's Guide

Agilent Technologies, Inc.
Printed in Malaysia
Edition 1
June 2008 E0608

*** 34980-90034 ***
34980-90034

Notices

© Agilent Technologies, Inc. 2008

No part of this manual may be reproduced in any form or by any means (including electronic storage and retrieval or translation into a foreign language) without prior agreement and written consent from Agilent Technologies, Inc. as governed by United States and international copyright laws.

Manual Part Number

34980-90034

Edition

First Edition, June 2008

Printed in Malaysia

Agilent Technologies, Inc.
3501 Stevens Creek Blvd
Santa Clara, CA 95052 USA

Microsoft® and Windows® are U.S. registered trademarks of Microsoft Corporation.

Software Revision

This guide is valid for the firmware that was installed in the instrument at the time of manufacture. However, upgrading the firmware may add or change product features. For the latest firmware and documentation, go to the product page at:

www.agilent.com/find/34980A

Warranty

The material contained in this document is provided “as is,” and is subject to being changed, without notice, in future editions. Further, to the maximum extent permitted by applicable law, Agilent disclaims all warranties, either express or implied, with regard to this manual and any information contained herein, including but not limited to the implied warranties of merchantability and fitness for a particular purpose. Agilent shall not be liable for errors or for incidental or consequential damages in connection with the furnishing, use, or performance of this document or of any information contained herein. Should Agilent and the user have a separate written agreement with warranty terms covering the material in this document that conflict with these terms, the warranty terms in the separate agreement shall control.

Technology Licenses

The hardware and/or software described in this document are furnished under a license and may be used or copied only in accordance with the terms of such license.

Restricted Rights Legend

U.S. Government Restricted Rights. Software and technical data rights granted to the federal government include only those rights customarily provided to end user customers. Agilent provides this customary commercial license in Software and technical data pursuant to FAR 12.211 (Technical Data) and 12.212 (Computer Software) and, for the Department of Defense, DFARS 252.227-7015 (Technical Data - Commercial Items) and DFARS 227.7202-3 (Rights in Commercial Computer Software or Computer Software Documentation).

Safety Notices

CAUTION

A **CAUTION** notice denotes a hazard. It calls attention to an operating procedure, practice, or the like that, if not correctly performed or adhered to, could result in damage to the product or loss of important data. Do not proceed beyond a **CAUTION** notice until the indicated conditions are fully understood and met.

WARNING

A **WARNING** notice denotes a hazard. It calls attention to an operating procedure, practice, or the like that, if not correctly performed or adhered to, could result in personal injury or death. Do not proceed beyond a **WARNING** notice until the indicated conditions are fully understood and met.

Additional Safety Notices

The following general safety precautions must be observed during all phases of operation of this instrument. Failure to comply with these precautions or with specific warnings or instructions elsewhere in this manual violates safety standards of design, manufacture, and intended use of the instrument. Agilent Technologies assumes no liability of the customer's failure to comply with the requirements.

General

Do not use this products in any manner not specified by the manufacturer. The protective features of this product may be impaired if it is used in a manner not specified in the operation instructions.

Before Applying Power

Verify that all safety precautions are taken. Make all connections to the unit before applying power.

Ground the Instrument

This product is provided with protective earth terminals. To minimize shock hazard, the instrument must be connected to the ac power mains through a grounded power cable, with the ground wire firmly connected to an electrical ground (safety ground) at the power outlet. Any interruption of the protective (grounding) conductor or disconnection of the protective earth terminal will cause a potential shock hazard that could result in personal injury.

Do Not Operate in an Explosive Atmosphere

Do not operate the instrument in the presence of flammable gases or fumes.

Do Not Remove the Instrument Cover

Only qualified, service-trained personal who are aware of the hazards involved should remove instrument covers. Always disconnect the power cable and any external circuits before removing the instrument cover.

Do Not Modify the Instrument

Do not install substitute parts or perform any unauthorized modification to the product. Return the product to an Agilent Sales and Service Office for service and repair to ensure that safety features are maintained.

In Case of Damage

Instruments that appear damaged or defective should be made inoperative and secured against unintended operation until they can be repaired by qualified service personnel.

Safety Symbols

 Alternating current

 Frame or chassis terminal

 Standby supply. Unit is not completely disconnected from ac mains when switch is off

 Caution, risk of electric shock

 Caution, refer to accompanying description

Waste Electrical and Electronic Equipment (WEEE) Directive 2002/96/EC



This product complies with the WEEE Directive (2002/96/EC) marking requirement. The affixed product label (see above) indicates that you **must not discard this electrical/electronic product in domestic household waste.**

Product Category: With reference to the equipment types in the WEEE directive Annex 1, this product is classified as a "Monitoring and Control instrumentation" product.

To return unwanted products, contact your local Agilent office, or go to www.agilent.com/environment/product for more information.

Technical Support

If you have questions about your shipment, or if you need information about warranty, service, or technical support, contact Agilent Technologies:

In the United States: (800) 829-4444
In Europe: 31 20 547 2111
In Japan: 0120-421-345

Or go to www.agilent.com/find/assist for information on contacting Agilent in your country of specific location. You can also contact your Agilent Technologies Representative.

The **Declaration of Conformity (DoC)** for the 34980A mainframe instrument can be found on page iii in the *34980A Mainframe User's Guide*. That DoC applies to the 34980A mainframe and all available plug-in modules.

Contents

1 Overview of the 34934A

34934A High Density Matrix Module	2
Operating Considerations	3
General Configuration Procedures for the 34934A	6
Benefits of Using the Terminal and Configuration Blocks with the 34934A	8
Use of the 34980A Web Browser Interface with the 34934A	11
Practical Examples for Selecting a Matrix Configuration Mode	12
4x32 Matrices	13
4x64 Matrices	16
4x128 Matrices	19
8x32 Matrices	21
8x64 Matrices	24
16x32 Matrices	26

2 Base Matrix Configuration

4x32 Matrix Configuration	30
Configuring a 4x32 Matrix using a Terminal Block	31
Configuring a 4x32 Matrix using a Configuration Block	37
Configuring a 4x32 Matrix by Direct Wiring	47
4x64 Matrix Configuration	49
Configuring a 4x64 Matrix using a Terminal Block	50
Configuring a 4x64 Matrix using a Configuration Block	56
Configuring a 4x64 Matrix by Direct Wiring	67
4x128 Matrix Configuration	69
Configuring a 4x128 Matrix using a Terminal Block	70
Configuring a 4x128 Matrix using a Configuration Block	76
Configuring a 4x128 Matrix by Direct Wiring	87
8x32 Matrix Configuration	89
Configuring an 8x32 Matrix using a Terminal Block	90
Configuring an 8x32 Matrix using a Configuration Block	97
Configuring an 8x32 Matrix by Direct Wiring	108
8x64 Matrix Configuration	111
Configuring an 8x64 Matrix using a Terminal Block	112
Configuring an 8x64 Matrix using a Configuration Block	118
Configuring an 8x64 Matrix by Direct Wiring	129
16x32 Matrix Configuration	132
Configuring a 16x32 Matrix using a Terminal Block	133
Configuring a 16x32 Matrix using a Configuration Block	140
Configuring a 16x32 Matrix by Direct Wiring	151

3 Expanded-Row Matrix Configuration

Linking Multiple 34934A Matrix Modules	156
Physical Arrangement of Multiple 34934A Modules in a 34980A Mainframe	157
Arranging Multiple 34934A Modules with Terminal Blocks	158
Arranging Multiple 34934A Modules with Configuration Blocks	160
Creating Expanded-Row Matrices Using Terminal Blocks	162
Interconnecting Terminal Blocks	163
Creating Expanded-Row Matrices Using Configuration Blocks	164
Interconnecting Configuration Blocks	165

4 SCPI Programming

Channel Numbering	168
SCPI Commands Used by the 34934A	169
Command Summary	169
Opening and Closing Channels	170
Querying Channels for Open or Closed State	171
Querying the Mainframe for Module Identity	172
Setting the Relay Protection Mode	172
Reading Relay Cycle Count	172

Index

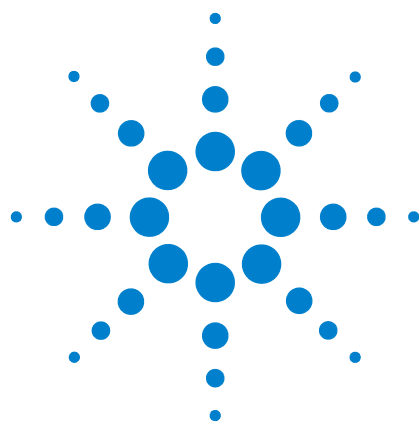

1 Overview of the 34934A

This chapter provides an overview of the 34934A High Density Matrix Module. It includes operating and general configuration information applicable to all matrix options from 4x32 to 16x32 and larger, with practical examples of the basic matrix options.

34934A High Density Matrix Module	2
Operating Considerations	3
General Configuration Procedures for the 34934A	6
Use of the 34980A Web Browser Interface with the 34934A	11
Benefits of Using the Terminal and Configuration Blocks with the 34934A	8
Practical Examples for Selecting a Matrix Configuration Mode	12
4x32 Matrices	13
4x32 Topology	13
4x32 1-Wire Operation, Test Circuit Examples	14
4x32 2-Wire Operation, Test Circuit Examples	15
4x64 Matrices	16
4x64 Topology	16
4x64 1-Wire Operation, Test Circuit Examples	17
4x64 2-Wire Operation, Test Circuit Example	18
4x128 Matrices	19
4x128 Topology	19
4x128 Test Circuit Example	20
8x32 Matrices	21
8x32 Topology	21
8x32 1-Wire Operation, Test Circuit Examples	22
8x32 2-Wire Operation, Test Circuit Example	23
8x64 Matrices	24
8x64 Topology	24
8x64 Test Circuit Example	25
16x32 Matrices	26
16x32 Topology	26
16x32 Test Circuit Example	27



34934A High Density Matrix Module

The 34934A is a 512 crosspoint matrix of non-latching reed switches, which you can operate in any of six different 1-wire topologies or three different 2-wire topologies. Larger matrices can be created from the base configurations by linking 34934A modules.

This matrix switch module offers a convenient way for you to connect multiple instruments to multiple points on your device under test (DUT). Instruments and DUTs can be connected to the rows and/or columns of a matrix.

Available base matrix configurations:

You may configure a *single* 34934A module:

- As quad **4x32** matrices (M1H, M1L, M2H, M2L). You can *operate* these as four independent matrices or as two independent 2-wire matrices.
- As dual **4x64** matrices (MH, ML). You can *operate* these as two independent matrices or as a single 2-wire matrix.
- As a single **4x128** matrix.
- As dual **8x32** matrices (MH, ML). You can *operate* these as two independent matrices or as a single 2-wire matrix.
- As a single **8x64** matrix.
- As a single **16x32** matrix.

[Chapter 2](#), “Base Matrix Configuration” provides detailed instructions for configuring each of these base matrices.

Expanded-Row Configurations You can create larger matrix configurations by combining *multiple* 34934A modules. Each individual module in that matrix is set to the same base configuration; the result *expands* the rows by adding columns from each module. For example: two modules, each set to 4x128, combine to create a 4x256 matrix.

[Chapter 3](#), “Expanded-Row Matrix Configuration” provides detailed instructions for interconnecting modules to create expanded-row matrices.

Operating Considerations

Connection to Voltage Sources

Although flexible, it is possible to connect more than one source at the same time with the 34934A. Make sure that dangerous or unwanted conditions are not created by these connections.

Safety Interlock

The 34934A module has a hardware Safety Interlock feature that automatically opens all 512 of the module's relays when the associated interlock pins on the D-Sub connectors (faceplate) or extension headers (terminal block or configuration block) lose continuity. This prevents signals from your field wiring from being present on exposed pins on the opposite D-sub connector or extension header.

If you connect to the D-Subs with custom cabling, you must provide continuity for the interlock pins as part of your field wiring / DUT assembly. Specific instructions for providing safety interlock continuity at the D-Sub connectors are provided for each configuration.

If you connect your field wiring using the optional terminal blocks or configuration blocks (available from Agilent) you must also provide continuity for the interlock pins. This can be accomplished by installing the supplied terminators in the extension headers. Specific instructions for providing safety interlock continuity at the extension headers are provided for each configuration.

Electrical Considerations

See the *Introduction to the Plug In Modules* chapter of the *34980A Mainframe User's Guide* for detailed environmental operating conditions for the 34980A mainframe and its installed modules. That guidance sets maximum per channel current and power ratings at rated voltage for pollution degree 1 (dry) and pollution degree 2 (possible condensation) conditions, for the 34934A matrix module.

Thermal Considerations

Because of mainframe thermal and power-supply restrictions, you can close no more than 64 channels (crosspoint relays) on the 34934A at one time. If you try to close a 65th channel, an error will be generated from the 34980A, and the channel will remain open.

Connection to the 34980A Analog Buses

This module does not directly connect to the 34980A mainframe's four 2-wire (HI, LO) 300V-rated Analog Buses.

- ABUS1 (MEAS) and ABUS2 (SENSE) connect to the internal DMM.
- ABUS3 and ABUS4 are four signal-routing only, and do not connect to the DMM.

You *can* connect from a row/column crosspoint directly to the 9-pin Analog Bus connector located on the 34980A's rear panel (see connector pinout below).

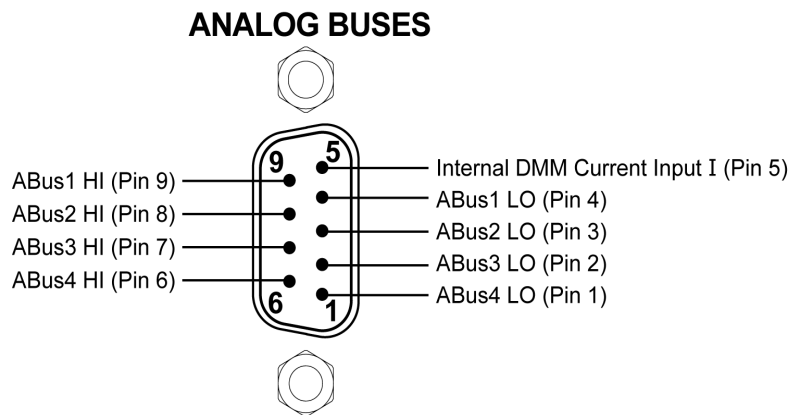

Analog Bus connector (as viewed from rear of instrument)

See the “*Electrical Operating Conditions*” and “*Analog Buses*” sections of the *34980A Mainframe User’s Guide* for complete instructions and safety precautions for accessing the Analog Buses.

Relay Protection

For reed relays, user-attached reactive loads and module parasitic capacitance may result in high in-rush currents. The 34934A module provides a method of protecting the reed relays from in-rush current, called Row Protection. The module incorporates sixteen 100Ω resistors, one for each bank of 32 columns within a row. Each of these resistors is in parallel with a bypass relay, as shown below.

Typical Row Schematic, Illustrating Row Protection Relay and Bypass Relay

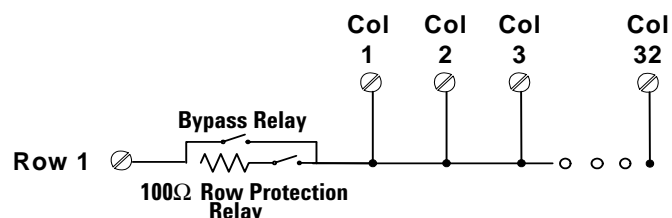

The operation of these in-rush resistors is user-selectable; you may choose from one of four modes on a per-module basis:

Auto-100 mode (default): In this mode, closing any channel also closes the protection relay for that row (only on *that* channel's 32-column bank), placing a 100Ω resistor in the signal path. The protection relay remains closed when any channel in that 32-channel bank is closed. The protection relay opens *after* all channels in that bank are opened.

Auto-0 mode: In this mode, closing a channel also closes the protection relay for that row (only on *that* channel's 32-column bank), placing the 100Ω resistor *momentarily* in the signal path to dissipate inrush current. The protection relay is then opened and shunted by the bypass relay.

Fixed mode: In this mode, all 16 protection relays are closed, placing the 100Ω resistors in each 32-channel bank's signal path. This operation is independent of the state (open, closed) of any channel relays. The protection relays remain closed until the row protection mode is changed, the instrument is reset, or power is cycled to the instrument.

Isolated mode: In this mode, all 16 protection relays and bypass relays are open, allowing no row signals into or out of the matrix. *This mode only applies to the 4x32, 8x32 and 16x32 matrices.* By isolating the rows, you can route signals column to column, using the row as a connection bus between columns within the same bank of 32 columns. The bypass relays remain open until the row protection mode is changed, the instrument is reset, or power is cycled to the instrument. This operation is independent of the state (open, closed) of any channel relays.

Use the `SYSTEM:MODE:ROW:PROTECTION` command to select the row protection mode for a specified 34934A module; the command applies to all rows on that module. See [“Setting the Relay Protection Mode” on page 172](#) for sample command syntax and examples.

General Configuration Procedures for the 34934A

Base Matrix Configurations

In practice, you will follow these steps to select, configure, and wire a matrix, using *a single* 34934A module:

1 Select a base matrix configuration:

- 4x32
- 4x64
- 4x128
- 8x32
- 8x64
- 16x32

The 4x32, 4x64 and 8x32 configurations can be *operated* as 2-wire channel pairs, though program commands.

2 Select your wiring method:

- use of an optional screw terminal block
- use of an optional configuration block
- direct wiring to the module's D-Sub connectors

3 *If using a terminal block:*

- a** Select and apply a wiring guide overlay to the terminal block, if appropriate for the chosen configuration.
- b** Place jumpers and terminators on the terminal block to configure the chosen base matrix.
- c** Connect your field wiring to the terminal block.

4 *If using a configuration block:*

- a** Place jumpers and terminators on the configuration block to configure the chosen base matrix and wiring options.
- b** Wire one jumper shorting safety interlock pins on each of the configuration block's D-Sub connectors.
- c** Connect your field wiring to the configuration block.

5 *If using direct wiring:*

- a** Connect your field wiring to the module's D-Sub connectors, using the corresponding D-Sub connector drawings and pin assignment table.
- b** Make additional wiring connections to configure the chosen base matrix configuration and safety interlock continuity.

Chapter 2, "Base Matrix Configuration" has one section for each base matrix configuration (e.g. 4x64, 16x32, etc.). Each section contains complete instructions for terminal block use, configuration block use and direct wiring.

Expanded-Row Matrix Configurations

In practice, you will follow these steps to select, configure, and wire an expanded-row matrix, combining two or more 34934A modules:

- 1 Select a matrix configuration (just a few possibilities are shown):
 - 4x256 (requires two 34934A modules, each with a base configuration of 4x128)
 - 4x512 (requires four 34934A modules; base configuration of 4x128)
 - 8x128 (requires two 34934A modules; base configuration of 8x64)
 - 16x64 (requires two 34934A modules; base configuration of 16x32)
 - 16x256 (requires eight 34934A modules; base configuration of 16x32)

The 4x32, 4x64 and 8x32 base configurations can be *operated* as 2-wire channel pairs, though program commands.

- 2 Select your wiring method:
 - use of an optional screw terminal block
 - use of an optional configuration block
 - direct wiring to the module's D-Sub connectors
- 3 Configure and wire each individual module, as if a stand-alone matrix, using the base configuration instructions in [Chapter 2](#).
- 4 Create a daisy-chain connection between the modules (either by interconnecting the terminal blocks or configuration blocks), using the instructions in [Chapter 3](#).

Benefits of Using the Terminal and Configuration Blocks with the 34934A

You have three options for connecting field wiring to the 34934A:

- Terminal Blocks
- Configuration Blocks
- Direct Wiring

Terminal Blocks

The terminal blocks provide convenient options for wiring rows and columns to screw terminals. Alternately, the rows can also be wired to 20-pin expansion headers on the block.

Terminal block 34934T-001 can be used for the 4x32, 4x64 and 4x128 matrices. Terminal block 34934T-002 can be used for the 8x32, 8x64 and 16x32 matrices. The 34934T-001 is shown below.

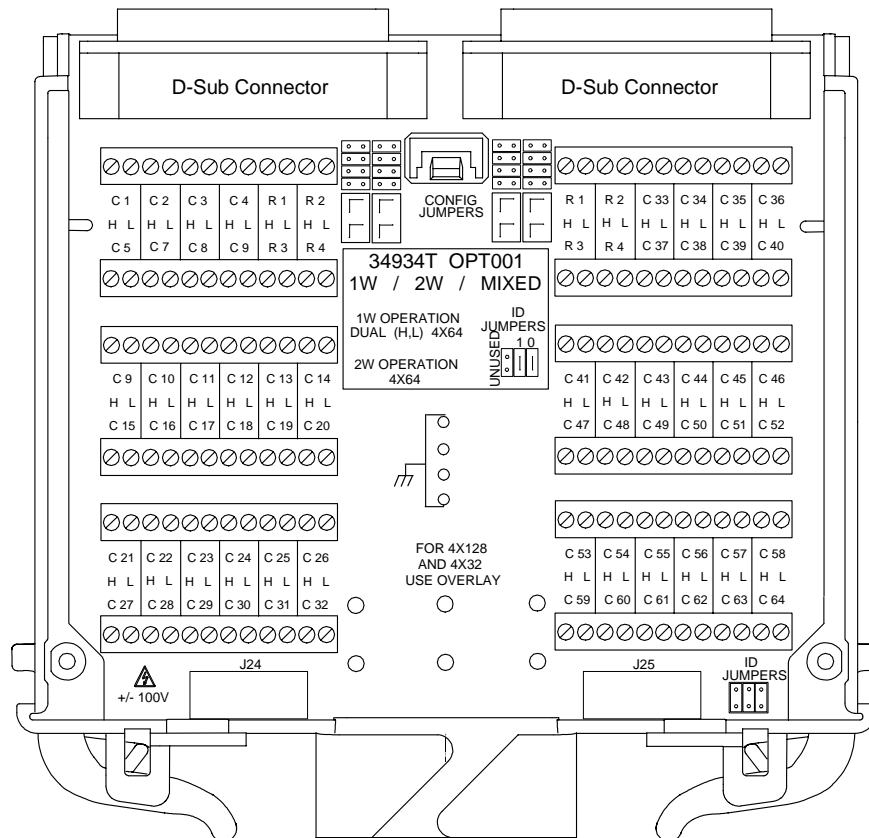

The terminal block's silk-screen provides screw terminal wiring guidance for one base configuration, but supports two others. Removable overlays provide the guidance for wiring the two other configurations.

The terminal block attaches to the 34934A module's D-Sub connectors. Matrix configuration is accomplished by placing jumpers on the terminal blocks. You choose a configuration, place jumpers, then wire your test circuit to the screw terminals and/or expansion headers.

Configuration Blocks

The configuration blocks provide flexible options for wiring rows and columns to D-Sub connectors. Alternately, the rows can also be wired to 20-pin expansion headers on the block.

Configuration block 34934C-001 can be used for the 4x32, 4x64 and 4x128 matrices. Configuration block 34934C-002 can be used for the 8x32, 8x64 and 16x32 matrices. The 34934C-001 is shown below.

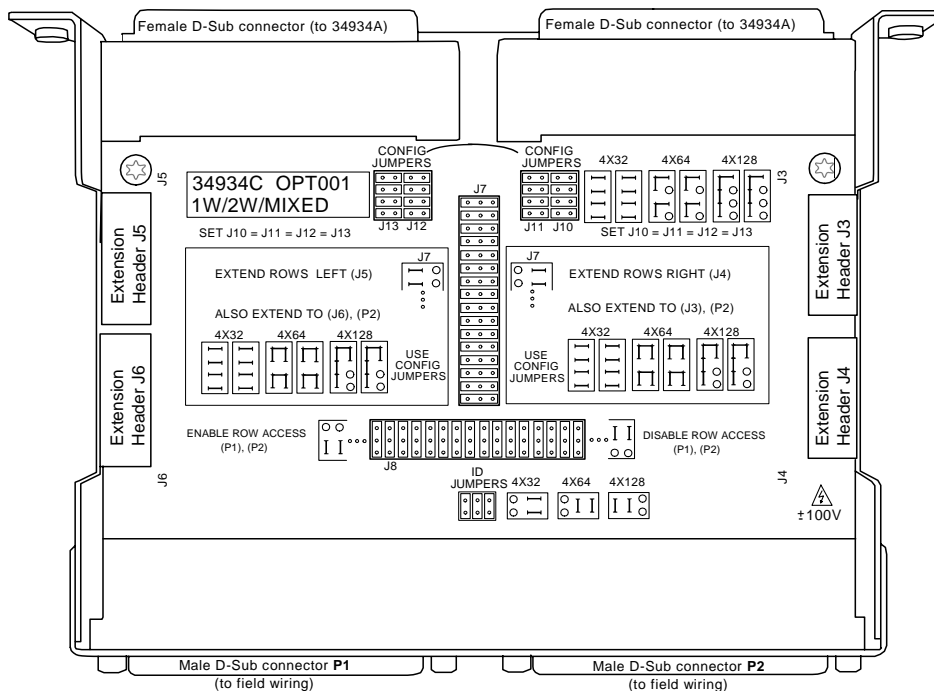

The configuration block attaches to the 34934A module's D-Sub connectors. Matrix configuration is accomplished by placing jumpers on the configuration block. You choose a configuration, place jumpers, then wire your test circuit to the *configuration block's* male D-Sub connectors and/or expansion headers. In addition, you will have to short two pins on each D-Sub to provide safety interlock continuity. *All other configuration is done within the block; this saves significant wiring time compared to direct wiring (which requires user-supplied configuration jumper wiring between the 34934A's D-Sub connectors).*

The configuration blocks can be used with a single 34934A. They are also used in expanded-row matrix configurations employing multiple 34934A modules; daisy-chain connections between the modules are made using the expansion headers.

NOTE

For the 34934C-001, the D-Sub wiring requirements are different than for the 34934A module. For the 34934C-002, both the D-Sub wiring requirements and pin assignments are different than for the 34934A module. Pay careful attention to which set of instructions you follow when making D-Sub connections!

Direct Wiring

The 34934A has two 78-pin male D-Sub connectors. You can connect your field wiring directly to these connectors using custom D-Sub cables. All matrix configuration must be accomplished by user-supplied wiring between these two cables. For some modes (8x32, 8x64 and 16x32), this additional wiring is extensive. *Use of the appropriate configuration block significantly reduces this additional wiring.*

Both the 34934A module and 34934C (Options 001 and 002) configuration blocks have 78-pin male D-Sub connectors. Wiring to these is covered in separate sections, and requires different wiring (34934A vs. 34934C) for each base configuration.

NOTE

For the 34934C-001, the D-Sub wiring requirements are different than for direct wiring to the 34934A module. For the 34934C-002, both the D-Sub wiring requirements and pin assignments are different than for the 34934A module. Pay careful attention to which set of instructions you follow when making D-Sub connections!

Use of the 34980A Web Browser Interface with the 34934A

The *34980A Web Browser* interface, accessible by PC via a LAN connection, is highly useful for helping you visualize the 34934A matrix topologies, nomenclature and channel numbering.

Using the Web Browser, you can observe and fully control the 34934A module. The Web Browser displays the matrix in use, with rows, columns and channel numbers for each matrix crosspoint. An example is shown below, illustrating the 4x128 matrix.

Agilent Technologies Multifunction Switch/Measure Unit

Observe Only
 Allow Full Control

Scan Control... Sequences... System Overview... Alarm

Modules in Mainframe

(1) 1, 4x128 Matrix [34934A-4x128] (5) Slot 5 empty
 (2) Slot 2 empty (6) Slot 6 empty
 (3) Slot 3 empty (7) Slot 7 empty
 (4) Slot 4 empty (8) Slot 8 empty

Analog Bus Overview

	Slot					
	1	2	3	4	5	6
ABus1						
ABus2						
ABus3						
ABus4						

Slot 1: Single 4x128 High Density Reed Matrix

Matrix 1	Row 1	Row 2	Row 3	Row 4
Column 128	1228	1428	1628	1828
Column 127	1227	1427	1627	1827
Column 126	1226	1426	1626	1826
Column 125	1225	1425	1625	1825
Column 124	1224	1424	1624	1824
Column 123	1223	1423	1623	1823
Column 122	1222	1422	1622	1822
Column 121	1221	1421	1621	1821
Column 120	1220	1420	1620	1820
Column 119	1219	1419	1619	1819
Column 118	1218	1418	1618	1818

Besides providing a convenient means to control the module, *the Web Browser offers the easiest method to view the channel map for any set configuration of the module.*

For complete guidance on LAN connection and navigating the 34980A Web Browser Interface, see the “Getting Started” chapter of the *34980A Mainframe Users Guide*.

Practical Examples for Selecting a Matrix Configuration Mode

The 34934A provides a wealth of configuration options, using just one module or in combinations of up to eight modules in a single mainframe. Each module combines four electrically separate 4x32 matrices; the 4x32 matrix is the basic elemental component for all larger matrices which can be configured by jumper settings and wiring.

This section provides—for each *base* matrix configuration—a description of the matrix topology and at least one example illustrating its application.

The examples include:

- A simplified electrical schematic of the matrix.
- Physical location of the row-protection resistors relative to the rows and columns.

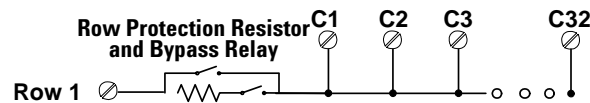

- Row jumpers (if needed) used to create the matrix from its 4-row by 32-column elemental components.



- Practical examples of physical locations to connect your test instrumentation and DUT to the matrix.
- **Bold lines** showing each complete electrical signal path (from DUT to instrument) through the matrix.
- The crosspoint relays included in each circuit path. Each relay has a channel number which uniquely identifies its row, column intersection; The channel numbering scheme is unique to each base matrix configuration (e.g. 4x32). “[Channel Numbering](#)” on page 168 provides the algorithm for how these channel numbers were computed.
- The syntax for the SCPI command used to close the circuit path, with the appropriate channel numbers.

In most of the examples, all test instruments and DUTs are connected to the columns, while the rows are used as busses to route signals between the components. For applications requiring protection from high in-rush currents, you may also connect your instruments or DUTs to the rows of the matrix, through the row protection resistors. Some examples illustrate this method of connection.

By exploring these examples, you can *choose the base matrix configuration best suited to your unique test application*; the available base matrix configurations are listed on [page 2](#). Then, you can proceed to the section of [Chapter 2](#) which provides configuration and wiring instructions for the chosen base matrix.

4x32 Matrices

4x32 Topology

You can select the 4x32 matrix configuration by setting jumpers on the appropriate terminal block or configuration block, or by D-Sub wiring.

Once configured for 4x32, the 34934A creates four matrices, each with 128 crosspoint non-latching reed relays organized in a 4-row by 32-column configuration. You can *operate* these as four independent *1-wire* matrices (M1H, M1L, M2H and M2L) or as (H,L) pairs of two independent *2-wire* matrices (M1 and M2).

In 1-wire operation, the four matrices are:

- M1H: uses H (high) columns C1H-C32H and H rows R1H-R4H of M1.
- M1L: uses L (low) columns C1L-C32L and L rows R1L-R4L of M1.
- M2H: uses H columns C1H-C32H and H rows R1H-R4H of M2.
- M2L: uses L columns C1L-C32L and L rows R1L-R4L of M2.

In 2-wire operation, the two matrices are:

- M1: uses both the H and L columns and rows; C1H-32H, C1L-C32L, R1H-R4H, R1L-R4L; of Matrix 1.
- M2: uses both the H and L columns and rows; C1H-32H, C1L-C32L, R1H-R4H, R1L-R4L; of Matrix 2.

As the examples illustrate, no physical matrix configuration changes are required for 2-wire operation. You wire your test devices between corresponding high and low matrix terminals or D-Sub pins, then operate the matrix in 2-wire mode by using SCPI paired commands (e.g. ROUT:OPEN:PAIR).

4x32 1-Wire Operation, Test Circuit Examples

The four examples below each show two 1-wire circuit paths. The M1 matrices wire up to the left side of the 34934T-001 terminal block; the M2 matrices wire on the right.

M1H

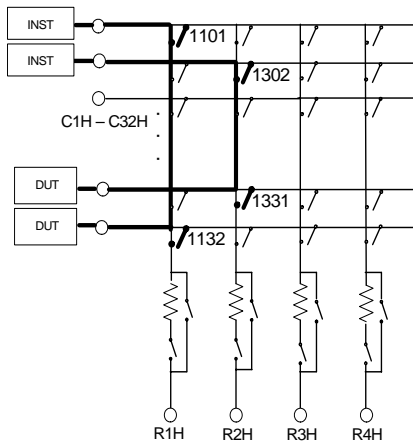

ROUT:CLOS (@1101,1132, 1302, 1331)
 Closes: row R1H @ columns C1H and C32H
 row R2H @ columns C2H and C31H

M2H

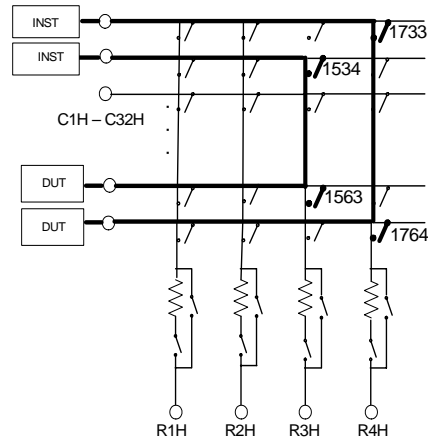

ROUT:CLOS (@1733,1764, 1534, 1563)
 Closes: row R4H @ columns C1H and C32H
 row R3H @ columns C2H and C31H

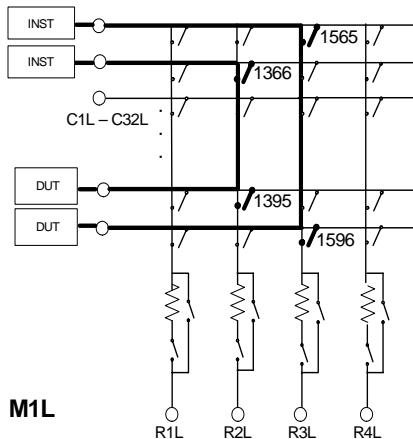

M1L

ROUT:CLOS (@1565,1596,1366,1395)
 Closes: row R3L @ columns C1L and C32L
 row R2L @ columns C2L and C31L

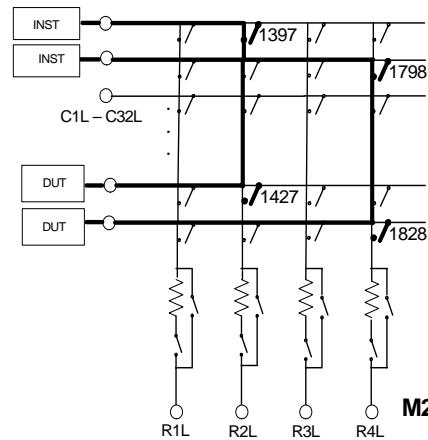

M2L

ROUT:CLOS (@1397,1427,1798,1828)
 Closes: row R2L @ columns C1L and C31L
 row R4L @ columns C2L and C32L

4x32 2-Wire Operation, Test Circuit Examples

The two examples below each show a 2-wire circuit path. One path uses matrix 1 (left side of the 34934T-001 terminal block); the other path uses matrix 2 (right side of terminal block).

These examples introduce one of the SCPI paired commands; ROUTE:CLOS:PAIR. With pair commands, you specify only the H channel numbers; but both the H and L channels of a pair are operated (e.g. opened or closed).

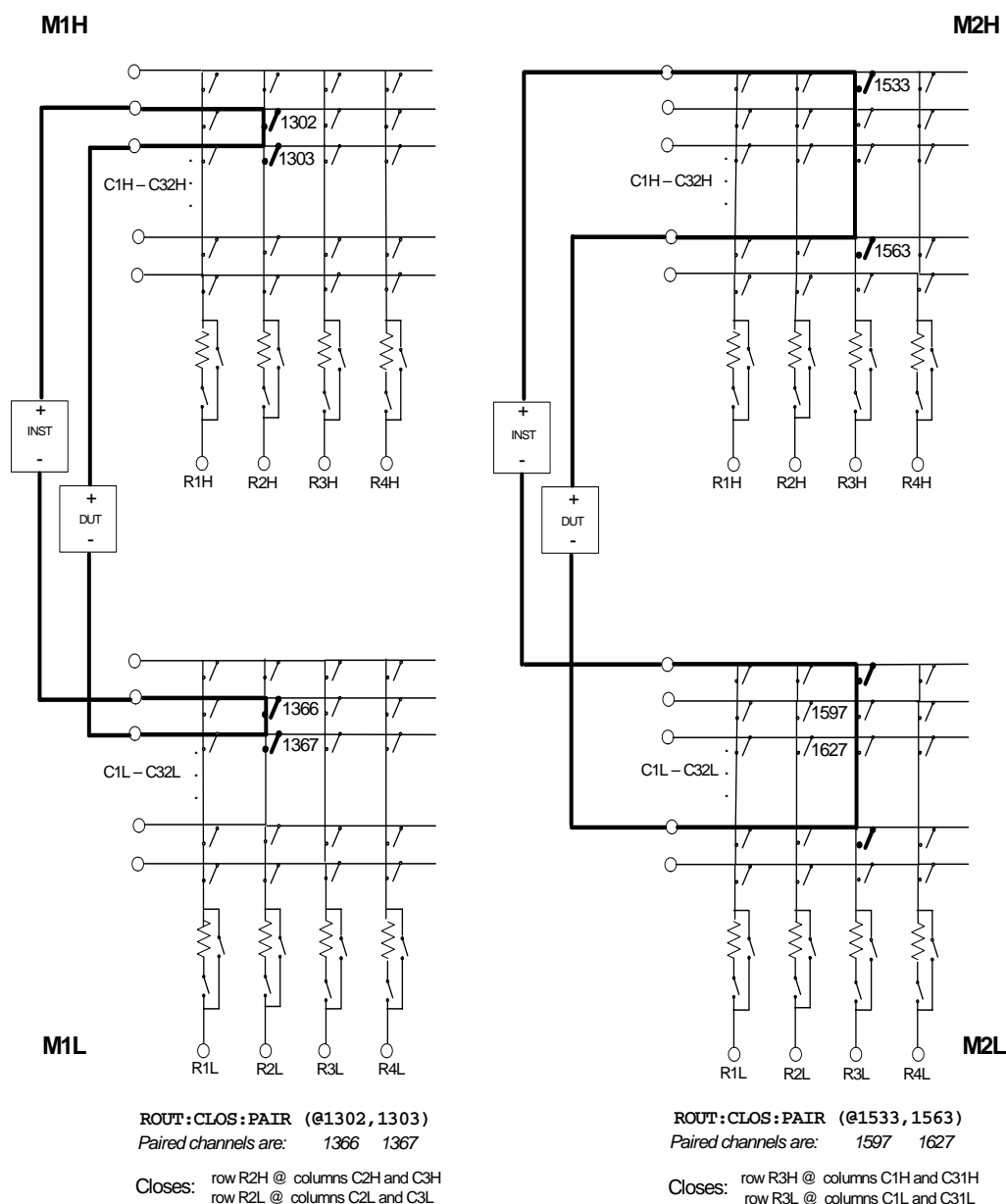

4x64 Matrices

4x64 Topology

You can select the 4x64 matrix configuration by setting jumpers on the appropriate terminal block or configuration block, or by D-Sub wiring.

Once configured for 4x64, the 34934A creates two matrices, each with 256 crosspoint non-latching reed relays organized in a 4-row by 64-column configuration. You can *operate* these as two independent *1-wire* matrices (MH, ML) or as a single *2-wire* matrix.

In 1-wire operation, the two matrices are:

- MH: uses H (high) columns C1H-C64H and H rows R1H-R4H.
- ML: uses L (low) columns C1L-C64L and L rows R1L-R4L.

In 2-wire operation, the matrix uses both the H and L columns and rows; C1H-64H, C1L-C64L, R1H-R4H and R1L-R4L.

As the examples illustrate, no physical matrix configuration changes are required for 2-wire operation. You wire your test devices between corresponding high and low matrix terminals or D-Sub pins, then operate the matrix in 2-wire mode by using SCPI paired commands (e.g. ROUT:OPEN:PAIR).

In either mode of operation, each matrix (MH, ML) is created by jumpering the rows on two of the 4x32 relay banks together. To do this, you will either place physical “CONFIG” jumpers on a terminal or configuration block, or create wiring jumpers by shorting pins between your D-Sub cables. The row jumpers are shown on the examples.

Each 32-column bank connects to the other through one 100Ω row protection resistor (with bypass relay) per row. The examples which follow show multiple ways to connect your DUT and test instrument; each circuit path *may* include series resistance, depending on the connection and programmed mode for row protection (see “[Relay Protection](#)” on page 5).

4x64 1-Wire Operation, Test Circuit Examples

The two examples below each show two 1-wire circuit paths.

On MH: The upper example path connects a DUT on column C1 to an instrument on row R1, through one 100Ω series row-protection resistor. The lower path shows both DUT and instrument connected to columns, but through two resistors.

On ML: The upper example path connects the DUT to an instrument on row R1; both crosspoints are on the same 32-relay bank, without the in-rush resistors. The lower example illustrates that even when DUT and instrument are on the same bank, the resistor is included in the circuit path.

In any path which makes a row connection (or which connects columns from separate 32-column banks), you can program the mode for the row protection resistor and bypass relay.

MH

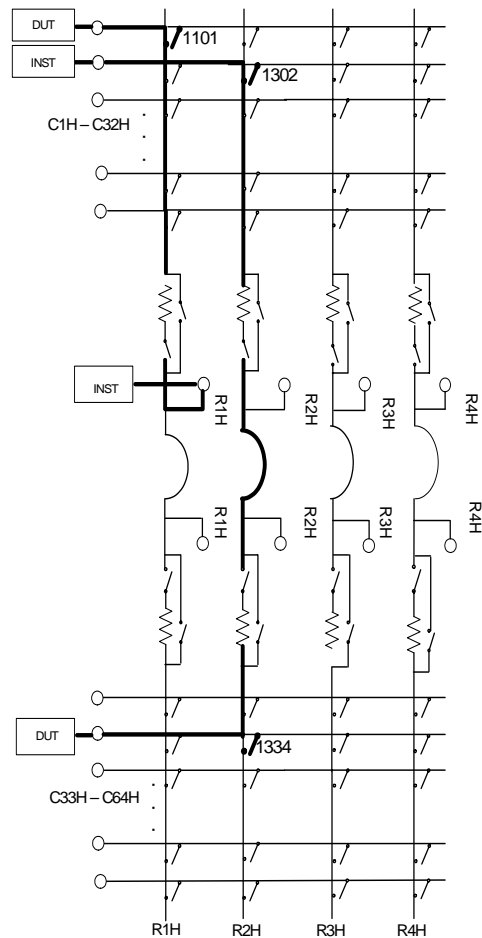

ROUT:CLOS (@1101,1302,1334)

Closes: row R1H @ column C1H
row R2H @ columns C2H and C34H

ML

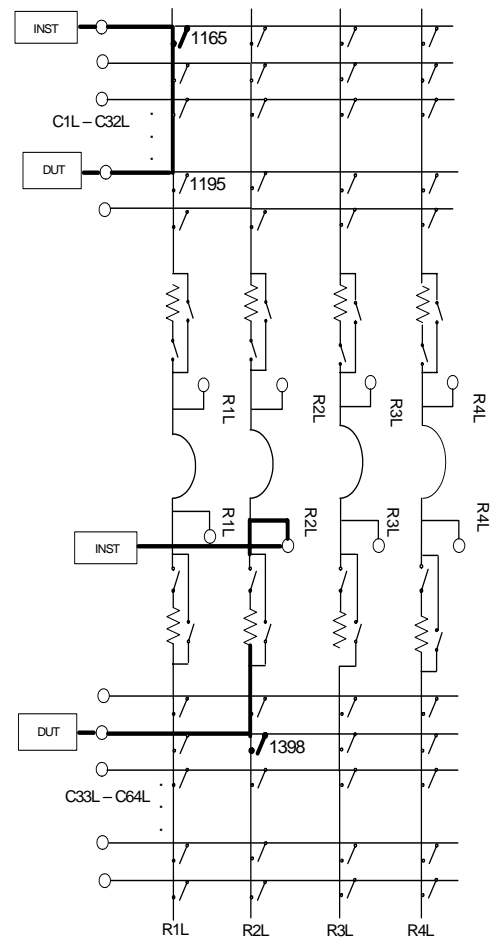

ROUT:CLOS (@1165,1195,1398)

Closes: row R1L @ columns C1L and C31L
row R2L @ column C34L

4x64 2-Wire Operation, Test Circuit Example

The example below shows a 2-wire circuit path through the matrix.

This example illustrates one of the SCPI paired commands; ROUTE:CLOSE:PAIR. To close two crosspoints in 2-wire operation, you specify two H crosspoints; the paired command also closes the two L crosspoints.

The complete circuit includes four 100Ω series row-protection resistors with bypass relays. As with any path which makes a row connection (or which connects columns from separate 32-column banks), you can program the mode for the row protection resistor and bypass relay.

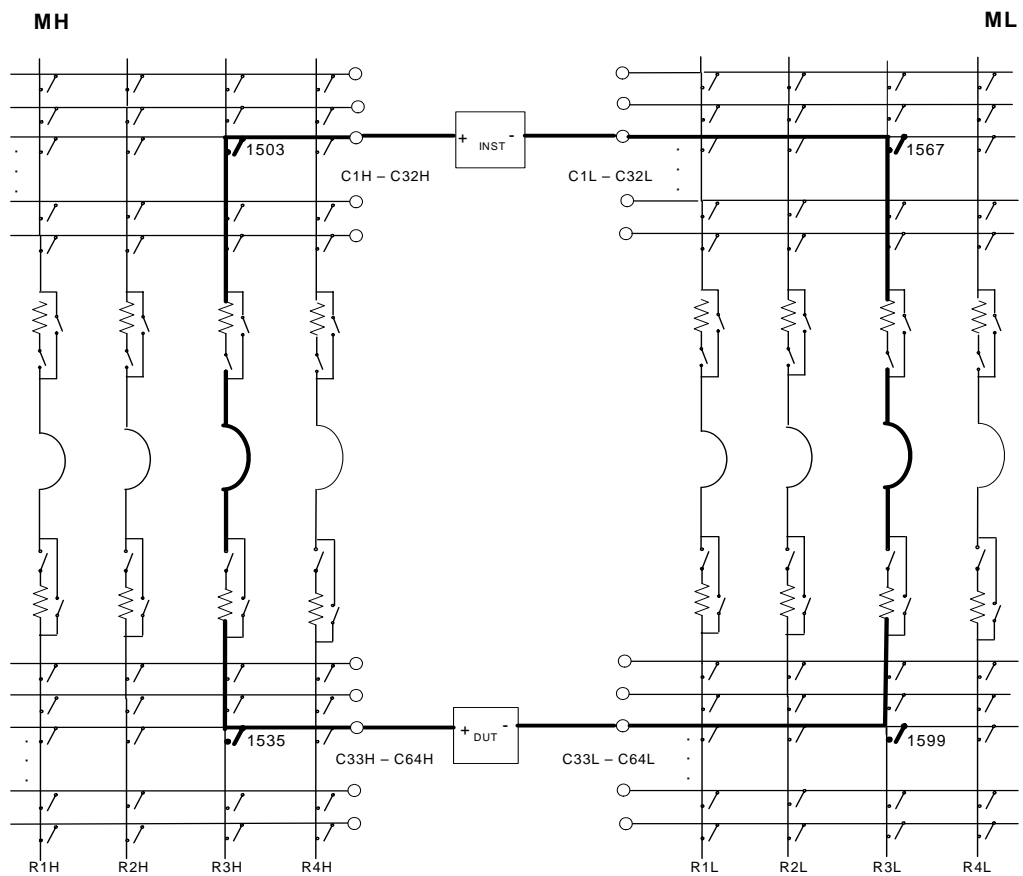

ROUTE:CLOS:PAIR (@1503,1535)
 Paired channels are: 1567 1599
 Closes: row R3H @ columns C3H and C35H
 row R3L @ columns C3L and C35L

4x128 Matrices

4x128 Topology

You can select the 4x128 matrix configuration by setting jumpers on the appropriate terminal block or configuration block, or by D-Sub wiring.

Once configured for 4x128, the 34934A creates a single matrix, with 512 crosspoint non-latching reed relays organized in a 4-row by 128-column configuration (greatest number of columns available using a single 34934A module). On the 34934T-001 terminal block, the columns are numbered 1-128; the rows R1-R4. In the D-Sub pin assignment tables, the numbering is C1-C128 and R1-R4.

The matrix is created by jumpering the rows on all four of the 4x32 relay banks together. To do this, you will either place physical “CONFIG” jumpers on a terminal or configuration block, or create wiring jumpers by shorting pins between your D-Sub cables. The row jumpers are shown on the example.

Each bank connects to the next through one 100 Ω row protection resistor (with bypass relay) per row. The examples which follow show multiple ways to connect your DUT and test instrument; each circuit path *may* include series resistance, depending on the connection and programmed mode for row protection (see “[Relay Protection](#)” on page 5).

4x128 Test Circuit Example

The example below shows three circuit paths through the matrix.

Paths #1 and #3 connect columns on separate 32-column banks, so these paths each include two 100Ω series row-protection resistors with bypass relays. No more than 200Ω can occur within any two crosspoints in the matrix.

Path #2 shows the instrument and DUT connected within the same 32-column bank, not including the resistors and relays.

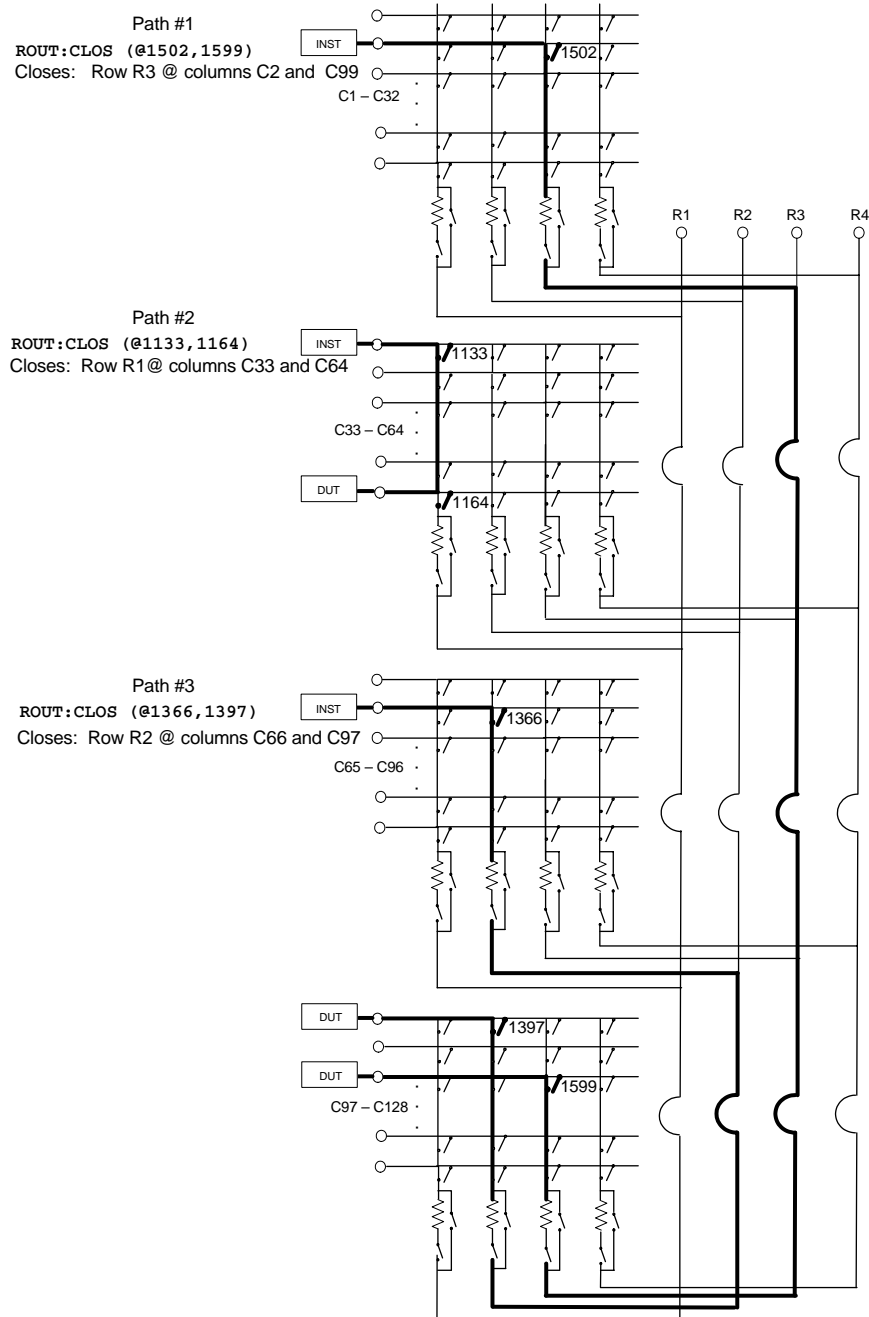

8x32 Matrices

8x32 Topology

You can select the 8x32 matrix configuration by setting jumpers on the appropriate terminal block or configuration block, or by D-Sub wiring.

Once configured for 8x32, the 34934A creates two matrices, each with 256 crosspoint non-latching reed relays organized in an 8-row by 32-column configuration. You can *operate* these as two independent *1-wire* matrices (MH, ML or as a single *2-wire* matrix.

In 1-wire operation, the two matrices are:

- MH: uses H (high) columns C1H-C32H and H rows R1H-R8H.
- ML: uses L (low) columns C1L-C32L and L rows R1L-R8L.

In 2-wire operation, a single matrix is formed by “pairing” MH and ML. The matrix uses both the H and L columns and rows; C1H-32H, C1L-C32L, R1H-R8H and R1L-R8L.

As the examples illustrate, no physical matrix configuration changes are required for 2-wire operation. You wire your test devices between corresponding high and low matrix terminals or D-Sub pins, then operate the matrix in 2-wire mode by using SCPI paired commands (e.g. ROUT:OPEN:PAIR).

In either mode of operation, each matrix (MH, ML) is created by jumpering the columns on two of the 4x32 relay banks together. To do this, you will either place physical “CONFIG” jumpers on a terminal or configuration block, or create wiring jumpers by shorting pins between your D-Sub cables. The column jumpers are not shown on the examples.

On the 34934T-002 terminal block, there are redundant “H” and “L” sets of terminals provided for columns 1-32, one set on each side of the block. The column terminals on each side of the block are shorted (by traces within the block) to their like-labeled counterparts on the other; you may make any column connection to the appropriate terminal on either side.

8x32 1-Wire Operation, Test Circuit Examples

The two examples below each show two 1-wire circuit paths through the matrix. The upper example (MH) shows one path with the DUT and test instrument both connected to the columns; the other path shows the test instrument connected through a row protection resistor. The lower example (ML) shows both paths connecting both DUT and test instrument to the columns, using the rows as connection busses.

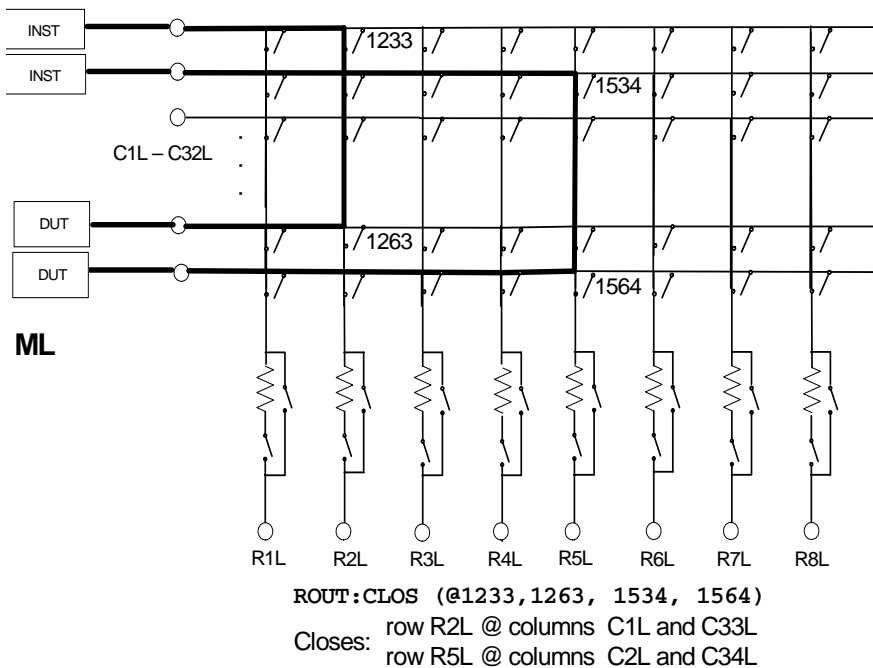
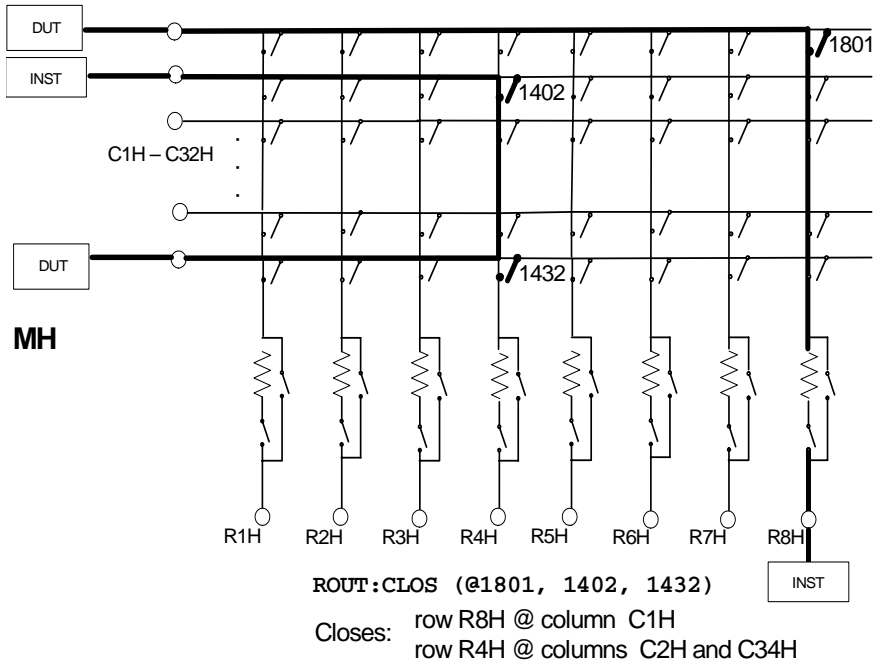

8x32 2-Wire Operation, Test Circuit Example

The example below shows a 2-wire circuit path through the matrix, with the instrument and DUT wired between the H and L terminals.

This example illustrates one of the SCPI paired commands; ROUTE:CLOSE:PAIR. To close two crosspoints in 2-wire operation, you specify two H crosspoints; the paired command also closes the two L crosspoints.

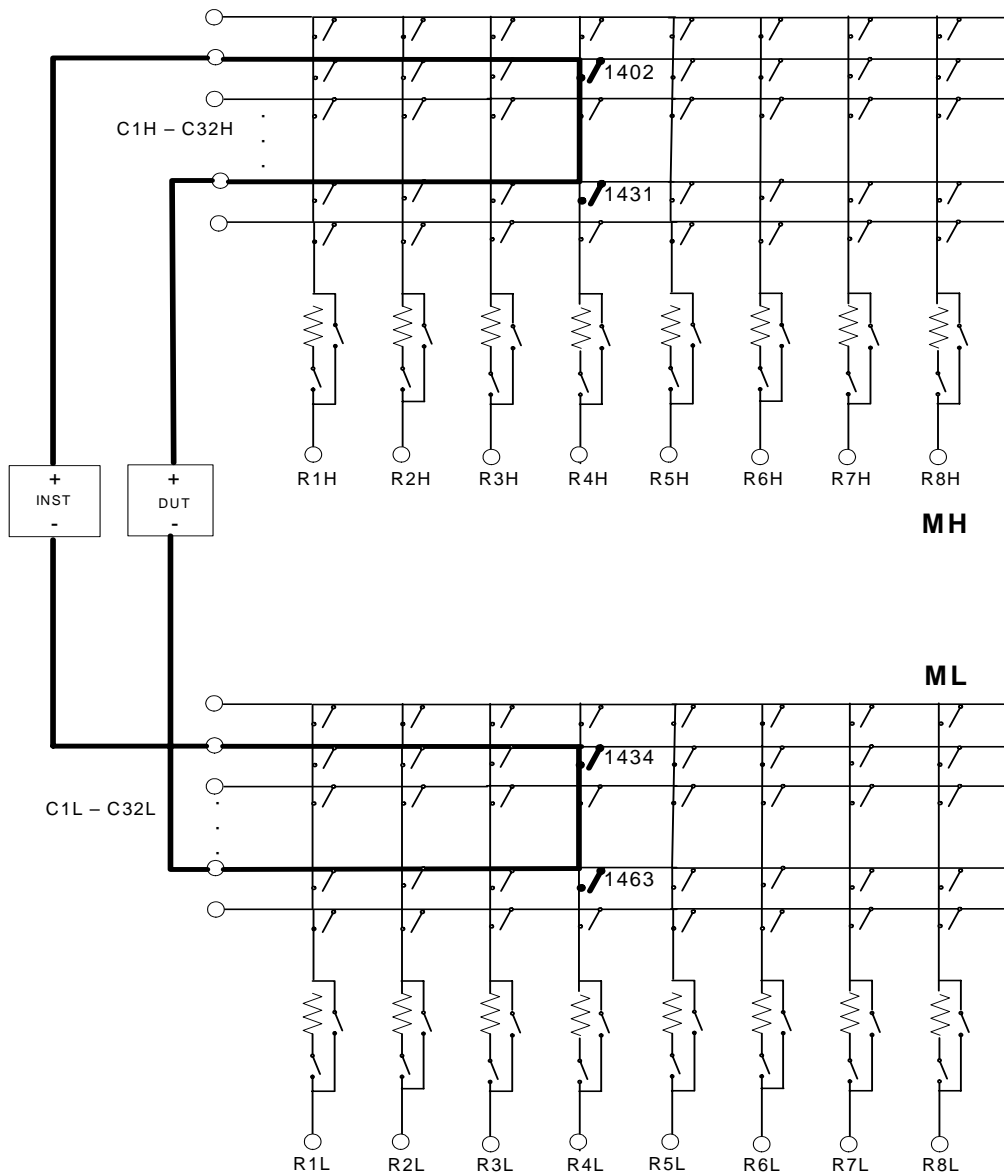

ROUTE:CLOSE:PAIR (@1402, 1431)
 Paired channels are: 1434 1463
 Closes: row R4H @ columns C2H and C31H
 row R4L @ columns C2L and C31L

8x64 Matrices

8x64 Topology

You can select the 8x64 matrix configuration by setting jumpers on the appropriate terminal block or configuration block, or by D-Sub wiring.

Once configured for 8x64, the 34934A creates a single matrix, with 512 crosspoint non-latching reed relays organized in a 8-row by 64-column configuration. On the 34934T-002 terminal block, the columns are numbered 1-64; the rows R1-R8. In the pin assignment diagrams and tables, the numbering is C1-C64 and R1-R8.

The matrix is created by jumpering the rows between pairs of the 4x32 relay banks together, then jumpering the columns. To do this, you will either place physical “CONFIG” jumpers on a terminal or configuration block, or create wiring jumpers by shorting pins between your D-Sub cables. The row jumpers are shown on the example; the column jumpers are not.

The row jumpers connect a bank to paired bank through one 100Ω row protection resistor (with bypass relay) per row. The example which follows show two ways to connect your DUT and test instrument; each circuit path *may* include series resistance, depending on the connection and programmed mode for row protection (see “[Relay Protection](#)” on page 5).

On the 34934T-002 terminal block, there are redundant sets of terminals provided for columns 1-64, one set on each side of the block. The column terminals on each side of the block are shorted (by traces within the block) to their like-labeled counterparts on the other; you may make any column connection to the appropriate terminal on either side.

8x64 Test Circuit Example

The example below shows two circuit paths through the matrix.

The upper example path connects a DUT on column C31 to an instrument on row R8, through one 100Ω series row-protection resistor. The lower path shows both DUT and instrument connected to columns using row R1, but through two resistors, as the two devices are on separate 32-column banks.

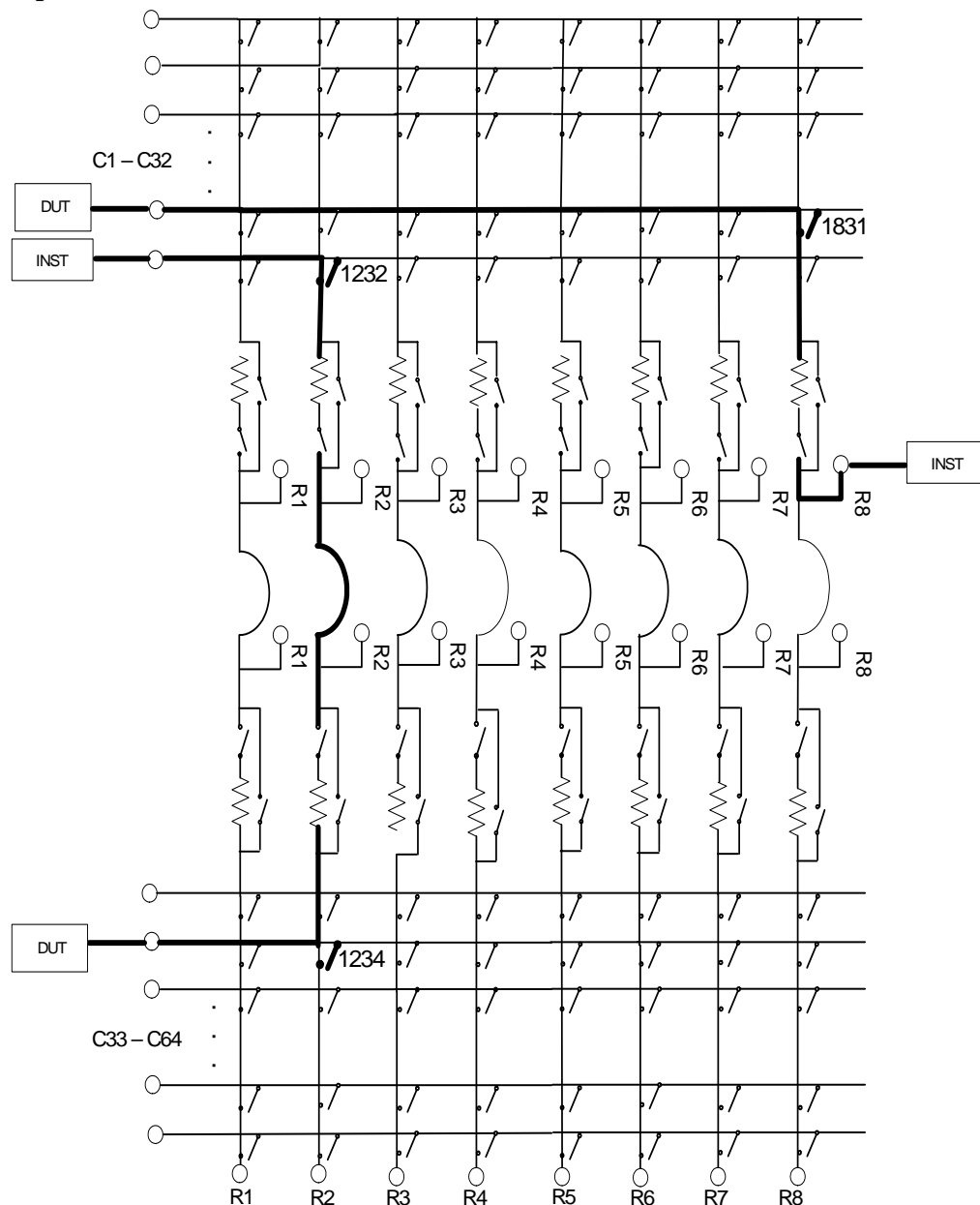

ROUT:CLOS (@1831,1232,1234)
 Closes: row R8 @ column C31
 row R2 @ columns C32 and C34

16x32 Matrices

16x32 Topology

You can select the 16x32 matrix configuration by setting jumpers on the appropriate terminal block or configuration block, or by D-Sub wiring.

Once configured for 16x32, the 34934A creates a single matrix, with 512 crosspoint non-latching reed relays organized in a 16-row by 32-column configuration. On the 34934T-002 terminal block, the columns are numbered 1-32; the rows R1-R16. In the pin assignment diagrams and tables, the numbering is C1-C32 and R1-R16.

The matrix is created by jumpering the columns on all four of the 4x32 relay banks together. To do this, you will either place physical “CONFIG” jumpers on a terminal or configuration block, or create wiring jumpers by shorting pins between your D-Sub cables. The column jumpers are not shown on the example.

On the 34934T-002 terminal block, there are redundant sets of terminals provided for columns 1-32, one set on each side of the block. Unlike the 8x32 and 8x64 modes, the like-labeled terminals on both sides of the block are not shorted to each other by traces in the block; you must supply a wire jumper for each column. Details on providing these jumpers are on [page 137](#). After these jumpers are placed, you may connect any column to the appropriate open terminal.

16x32 Test Circuit Example

The example below shows two circuit paths through the matrix. The upper path shows the DUT and test instrument both connected to columns through row R10; the other path shows the test instrument connected through a row protection resistor on row R14. *That* circuit path *may* include series resistance, depending on the programmed mode for row protection (see “Relay Protection” on page 5).

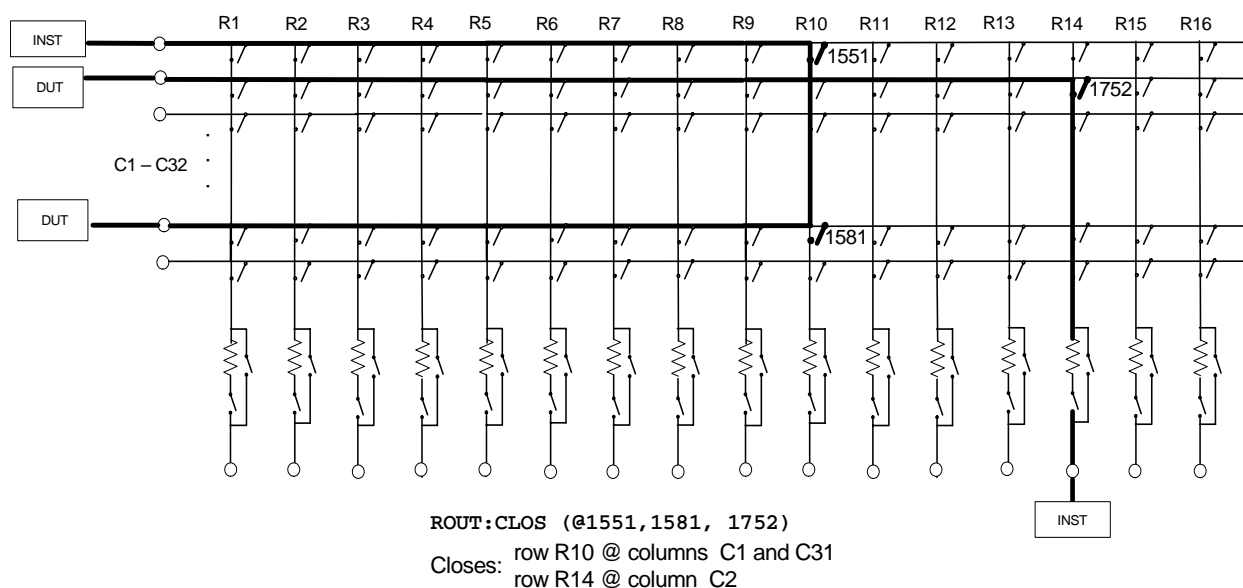

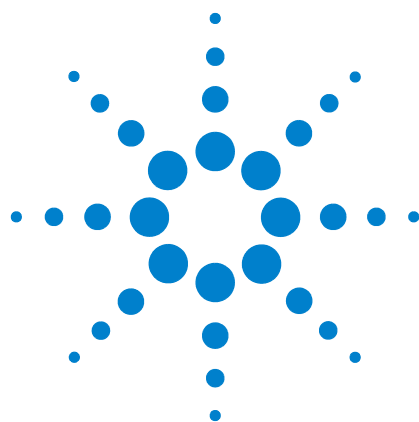

2 Base Matrix Configuration

This chapter contains six independent sections. Each contains complete configuration and wiring instructions for creating a selected base matrix using *one* 34934A module.

4x32 Matrix Configuration	30
Configuring a 4x32 Matrix using a Terminal Block	31
Configuring a 4x32 Matrix using a Configuration Block	37
Configuring a 4x32 Matrix by Direct Wiring	47
4x64 Matrix Configuration	49
Configuring a 4x64 Matrix using a Terminal Block	50
Configuring a 4x64 Matrix using a Configuration Block	56
Configuring a 4x64 Matrix by Direct Wiring	67
4x128 Matrix Configuration	69
Configuring a 4x128 Matrix using a Terminal Block	70
Configuring a 4x128 Matrix using a Configuration Block	76
Configuring a 4x128 Matrix using a Configuration Block	76
8x32 Matrix Configuration	89
Configuring an 8x32 Matrix using a Terminal Block	90
Configuring an 8x32 Matrix using a Configuration Block	97
Configuring an 8x32 Matrix by Direct Wiring	108
8x64 Matrix Configuration	111
Configuring an 8x64 Matrix by Direct Wiring	129
Configuring an 8x64 Matrix using a Configuration Block	118
Configuring an 8x64 Matrix by Direct Wiring	129
16x32 Matrix Configuration	132
Configuring a 16x32 Matrix using a Terminal Block	133
Configuring a 16x32 Matrix using a Configuration Block	140
Configuring a 16x32 Matrix by Direct Wiring	151



4x32 Matrix Configuration

To create a 4x32 matrix, you may connect your field wiring to the 34934A by three methods:

Terminal Block You can use terminal block 34934T-001. The terminal block connects to the 34934A's two D-Sub connectors; it provides 12 blocks of 12 screw terminals each, and a *4x32 removable overlay* (supplied with the 34934T-001) which provides guidance for field wiring the 4x32 matrices. Follow these sections in order to configure and wire the terminal block:

- “34934T-001 Terminal Block: 4x32 Layout” on page 31
- “34934T-001 Terminal Block: 4x32 Jumper Configuration” on page 33
- “34934T-001 Terminal Block: 4x32 Wiring” on page 35

Configuration Block You can use configuration block 34934C-001. Follow these sections in order to configure and wire the configuration block:

- “34934C-001 Configuration Block: Layout” on page 37
- “34934C-001 Configuration Block: 4x32 Jumper Configuration” on page 38
- “34934C-001 Configuration Block: Wiring” on page 43

NOTE

Use of the 34934C-001 precludes use of a piggy-backed 34934T-001 terminal block for field wiring connections; the combination is not mechanically reliable.

Direct Wiring You can wire directly to the module's D-Sub connectors using custom cabling. You will have to short specific pins on and between the D-Sub connectors to create the 4x32 configuration. Review *both* these sections *before* wiring to the module's D-Subs:

- “Configuring a 4x32 Matrix by Direct Wiring” on page 47
- “34934A Module D-Sub Connectors: 4x32 Wiring” on page 48

Configuring a 4x32 Matrix using a Terminal Block

34934T-001 Terminal Block: 4x32 Layout

This terminal block with screw-type connections is labeled with the model number and the abbreviated module name. In addition, space is available on the label for you to write the slot number.

The 34980A Product Reference CD (shipped with the module) contains a 34934T Wiring Log for you to document your wiring configuration for this module. You can open the wiring log file in Microsoft® Excel® or Adobe® Acrobat® format.

The 4x32 removable overlay (supplied with the 34934T-001) shows the row and column terminals for the 4x32 matrix configuration:

Wire Size:
20 AWG (Typical)

18 AWG (Screw Terminal Max)

24AWG (Max if all 144 lines are used)

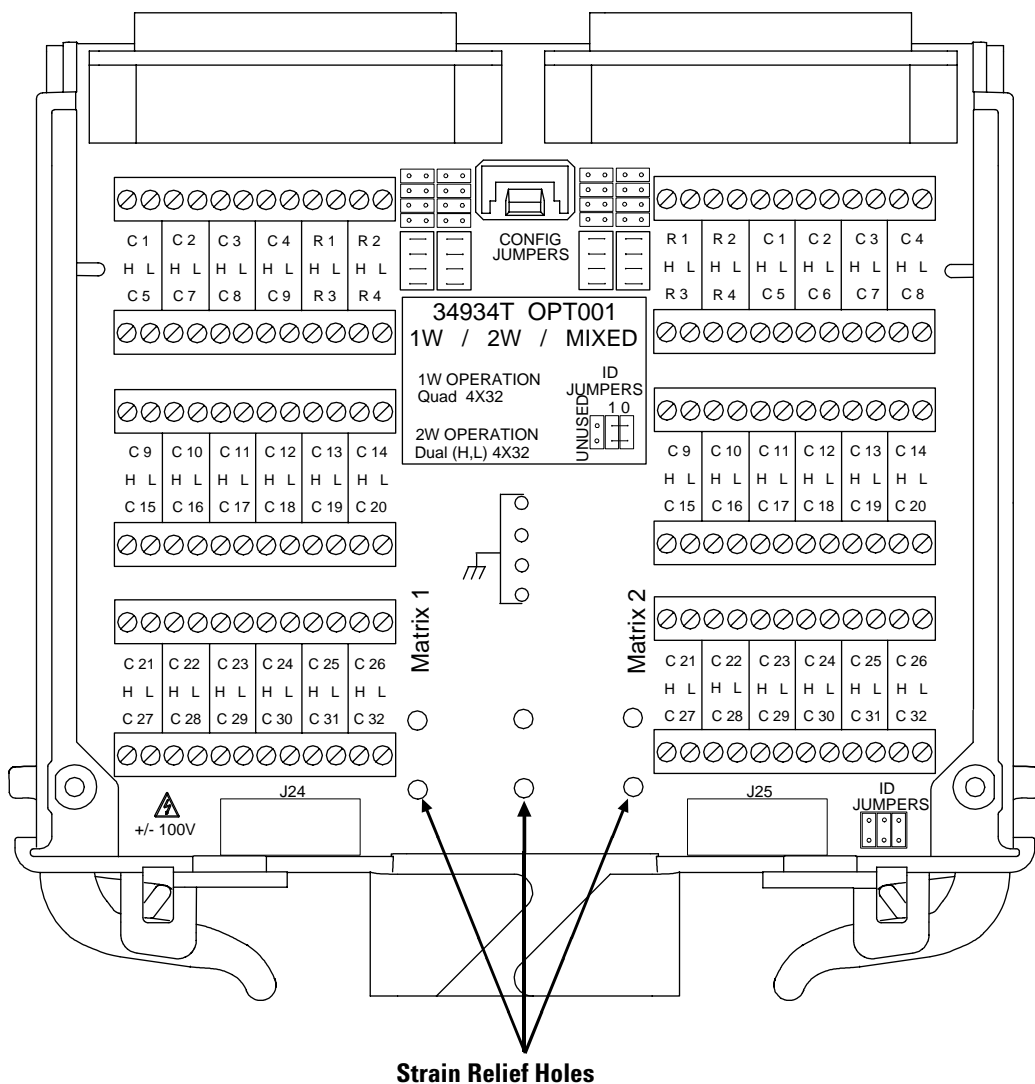

Note the six strain relief holes provided in the terminal block PCB. See the following page for instructions on providing wiring strain relief.

Terminal block strain relief

To reduce strain on the wiring at the terminals and maintain connection reliability, a strain relief feature has been incorporated into the terminal block design. Six holes have been placed near the lower edge of the circuit board, lined up with holes in the terminal block's bottom cover, as seen on “34934T-001 Terminal Block: 4x32 Layout” on page 31.

To use this feature:

- 1 Once all jumpers are installed and wiring is connected to the terminals, arrange the wires leading away from the terminal block in two bundles. This is easiest if the left bundle leads to the terminals on the left side of the block, and conversely for the right side.
- 2 Insert a cable tie (tie-wrap, zip-tie) down through each of the four outside holes in the PCB, continuing down through the holes in the terminal block's bottom cover.
- 3 Route these cable ties up through the center holes in the bottom cover and PCB.
- 4 Close and tighten the cable ties as required, and remove any excess so that it does not interfere with cover closure.

The completed bundles are shown below.

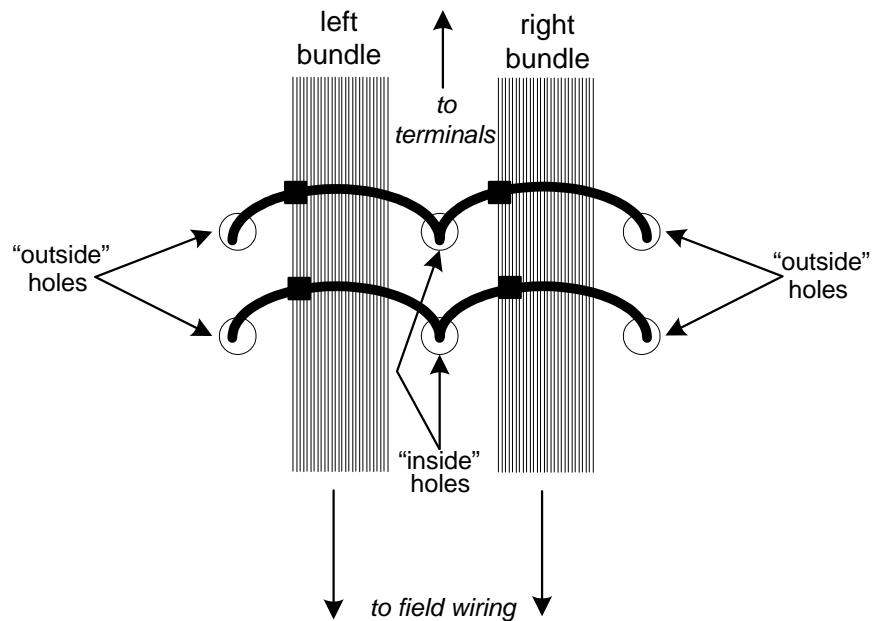

34934T-001 Terminal Block: 4x32 Jumper Configuration

This terminal block has three types of jumpers which must be connected to configure the 4x32 matrix (matrices):

- **CONFIG Jumpers:** place these 2-pin jumpers *identically on all four* 4x2 blocks of jumper pins located near the board's female D-Sub connectors, as shown.
- **ID Jumpers:** place these 2-pin jumpers on a 2x3 block of jumper pins on the lower right corner of the board, as shown.
- **Safety Interlock Continuity Jumpers:** place the supplied pre-wired terminators or equivalent custom wiring on the two 20-pin extension headers at the bottom of the terminal block, as shown.

Placing CONFIG Jumpers for 4x32 The CONFIG jumper area—shown below with jumpers removed—has an illustration below it (on the *4x32 removable overlay*) providing jumper placement guidance for 4x32 matrix configuration.

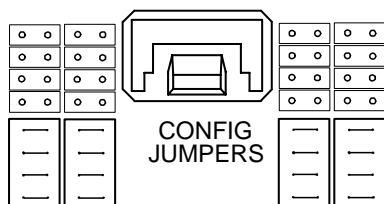

There are four 4x2 blocks of CONFIG JUMPER pins on either side of the board's center—you *must* set all four blocks identically.

Place sixteen horizontally positioned jumpers as shown below.

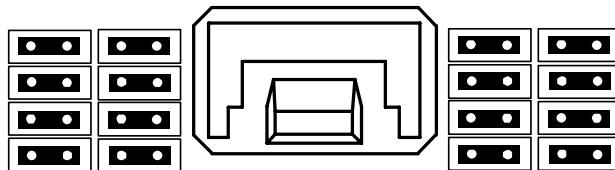

Placing ID Jumpers for 4x32 The ID jumpers allow the 34980A to recognize the 4x32 matrix configuration upon mainframe bootup. Jumper placement guidance is provided on the *4x32 removable overlay* (below left); the ID jumper block is shown at right with jumpers removed.

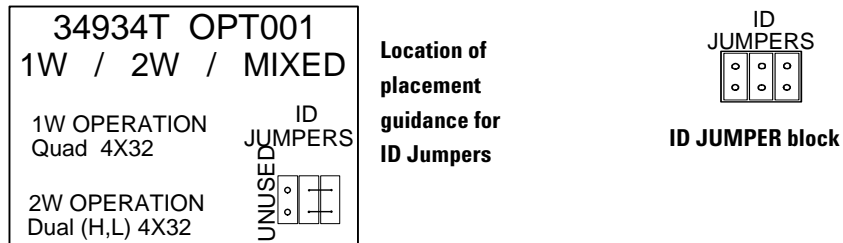

To set the correct ID code for 4x32, place two horizontally positioned jumpers as shown below.

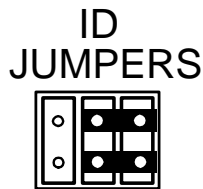

Placing Safety Interlock Continuity Jumpers for 4x32 At the bottom (end opposite the D-Sub connectors) of the terminal block are two 20-pin extension headers—marked J24 and J25 on the circuit board. These headers provide access to the module's rows. Pins 19 and 20 on each header must be shorted to provide continuity for the module's safety interlock function.

Two keyed 20-pin terminators are supplied for providing safety interlock continuity. Install the terminators securely in the headers, as shown below.

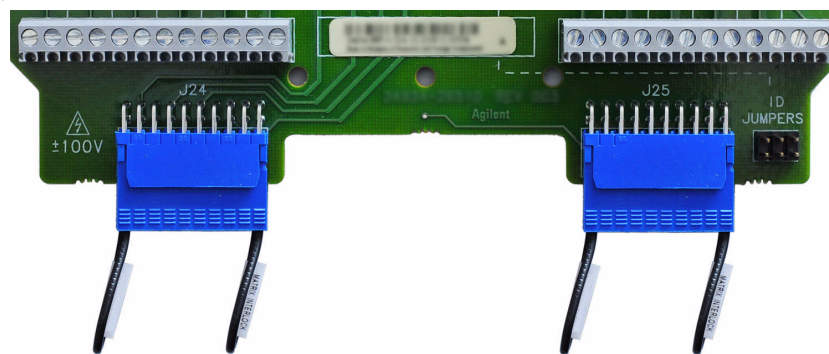

The supplied terminators incorporate both the shorting jumper for pins 19 and 20 and a jumper precluding connection to pins 1 and 2. Detailed pin diagrams for these terminators are provided on [page 36](#).

34934T-001 Terminal Block: 4x32 Wiring

Once the required jumpers have been placed to configure the terminal block as 4x32, you are ready to make row and column connections to the terminal block.

You may connect to the module's rows and columns by wiring to the screw terminals marked C1 through C32 (H, L) and R1 through R4 (H, L) on the *4x32 removable overlay* (see [“34934T-001 Terminal Block: 4x32 Layout”](#) on page 31). The combined weight of these wires can create significant strain on the wiring; to minimize this see [“Terminal block strain relief”](#) on page 32.

However, you may prefer to use physically separate cabling for the row connections (e.g. if you connect your DUT to the columns and your measurement device(s) to the rows). The terminal block's extension headers J24 and J25 provide access to the rows; you can make row connections to the central 16 terminals (pins 3-18) on the supplied terminators you installed in [“Placing Safety Interlock Continuity Jumpers for 4x32”](#) on page 34.

Below is an illustration of the possible locations for making row signal connections to the 34934T-001:

You can connect row signals to the screw terminals here...

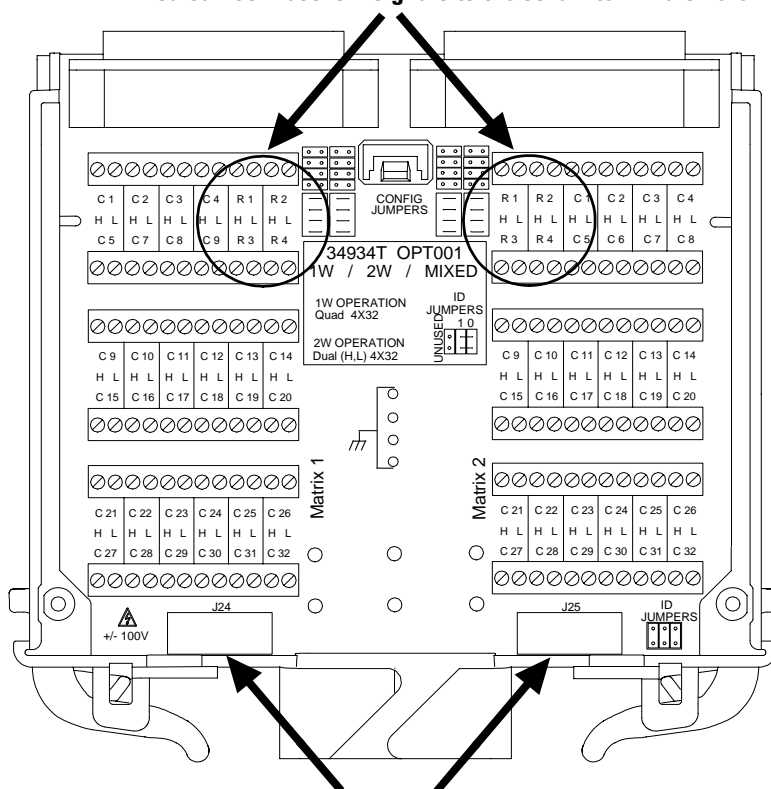

...or to the central 16 pins of extension headers J24 and J25 here.

The following subsection outlines how to make row connections to extension headers J24 and J25.

Extension Header (Row Signal) Wiring for 4x32 The position of extension headers J24 and J25 are marked on the 34934T-001’s silk-screen. Oriented with the terminal side of the board up, the pin numbers for these headers are shown below.

Extension Headers J24 and J25

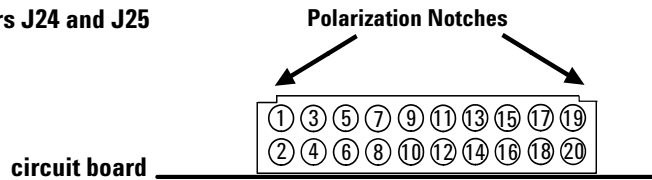

The supplied 20-pin terminators are identical, but the pin assignments for 4x32 are not (Matrix 1 rows are on J24; Matrix 2 rows are on J25). The terminal numbers—corresponding to the headers—are shown below. *Pay careful attention to the indexing keys on the connectors, to correctly identify terminal #1.*

20-Pin Terminators for J24 and J25

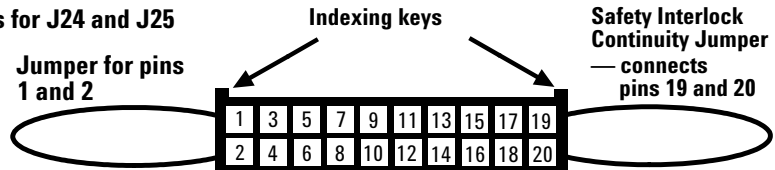

You must fabricate custom cabling to make row signal connections to the central 16 pins (3-18) of these headers, using the pin assignments below. The supplied blue terminators accommodate 22 AWG coated wire, fitted to “crimp-to-wire” contacts with latch tabs (FCI part #76357-301LF or equivalent).

34934T-001: Extension Header Pin Assignments for 4x32

Header J24				Header J25			
Description	Pin	Description	Pin	Description	Pin	Description	Pin
No Connect	1	No Connect	2	No Connect	1	No Connect	2
M1 R1H	3	M1 R1H	4	M2 R1H	3	M2 R1H	4
M1 R1L	5	M1 R1L	6	M2 R1L	5	M2 R1L	6
M1 R2H	7	M1 R2H	8	M2 R2H	7	M2 R2H	8
M1 R2L	9	M1 R2L	10	M2 R2L	9	M2 R2L	10
M1 R3H	11	M1 R3H	12	M2 R3H	11	M2 R3H	12
M1 R3L	13	M1 R3L	14	M2 R3L	13	M2 R3L	14
M1 R4H	15	M1 R4H	16	M2 R4H	15	M2 R4H	16
M1 R4L	17	M1 R4L	18	M2 R4L	17	M2 R4L	18
IL1	19	IL2	20	IL3	19	IL4	20

Note that each row signal (R1 through R4 (H,L) for each Matrix (1, 2) is routed out on two pins on the extension headers. You can make row signal connections to either row (upper, lower) of the connector.

If you are going to create an expanded-row matrix using multiple modules and terminal blocks, plan your wiring placement for each terminal block carefully, to allow for a daisy-chain interconnection between terminal blocks—in addition to any row wiring you may connect to the expansion headers. This interconnection is illustrated in “[Arranging Multiple 34934A Modules with Terminal Blocks](#)” on page 158.

Configuring a 4x32 Matrix using a Configuration Block

34934C-001 Configuration Block: Layout

This configuration block is labeled with the model number and the abbreviated module name.

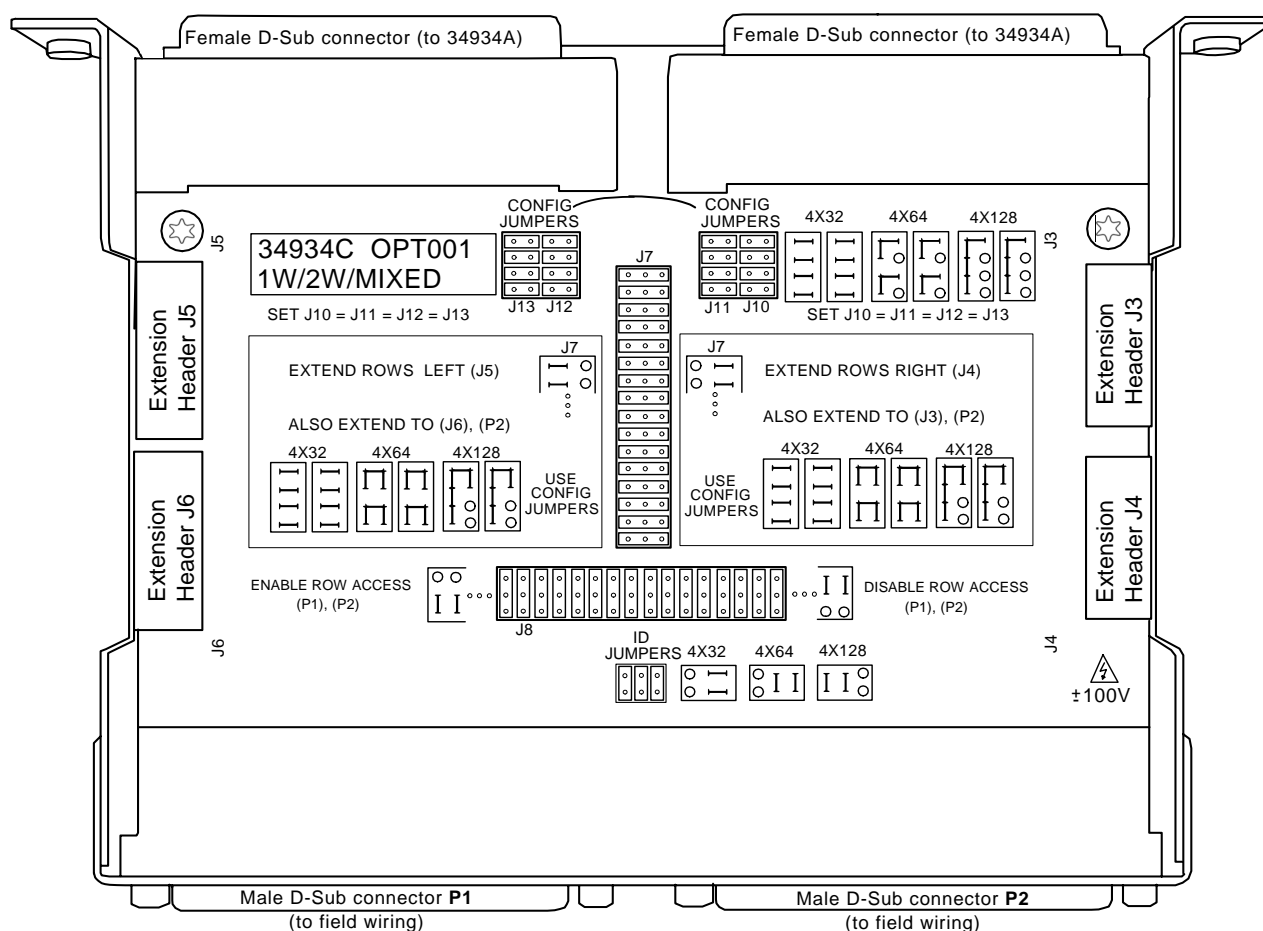

Note four types of on-board jumpers you'll have to set to configure this board; some will be familiar from the configuration descriptions of the *terminal blocks*, but some are new. Instructions for setting these are provided in "[34934C-001 Configuration Block: 4x32 Jumper Configuration](#)" on page 38.

- ID Jumpers
- CONFIG Jumpers (J10, J11, J12 and J13)
- Row Extension Jumpers (J7)
- Row Access Jumpers (J8)

Also note the four extension headers (J3, J4, J5 and J6). Instructions for wiring to these are provided in "[34934C-001 Configuration Block: Wiring](#)" on page 43.

34934C-001 Configuration Block: 4x32 Jumper Configuration

The configuration block has five types of jumpers which must be connected to configure it for use in an expanded 4-row matrix. In this section, you will place:

- **ID Jumpers:** place these 2-pin jumpers on a 2x3 block of jumper pins near the bottom center of the board. See [“Placing ID Jumpers on the 34934C-001 Configuration Block for 4x32”](#) on page 39.
- **CONFIG Jumpers:** place these 2-pin jumpers *identically on all four* 4x2 blocks of jumper pins located near the board’s female D-Sub connectors. See [“Placing CONFIG Jumpers on the 34934C-001 Configuration Block for 4x32”](#) on page 39.
- **Row Extension Jumpers:** place these 16-pin jumpers on a 16x3 block (J7) of jumper pins at the board’s center. See [“Placing Row Extension Jumpers on the 34934C-001 Configuration Block”](#) on page 40.
- **Row Access Jumpers:** place these 16-pin jumpers on a 3x16 block of jumper pins located just above the ID Jumpers. See [“Placing Row Access Jumpers on the 34934C-001 Configuration Block”](#) on page 41.
- **Safety Interlock Continuity Jumpers:** place the supplied pre-wired terminators on the four 20-pin extension headers at the sides of the configuration block. See [“Placing Safety Interlock Continuity Jumpers on the 34934C-001 Configuration Block”](#) on page 42.

Placing ID Jumpers on the 34934C-001 Configuration Block for 4x32 The ID jumpers allow the 34980A to recognize the base matrix configuration used by the 34934C-001 upon mainframe bootup. The ID jumpers are placed in a 2x3 jumper block, located below jumper block J8. Jumper placement guidance is provided on the configuration block’s silk-screen, to the right of the jumpers:

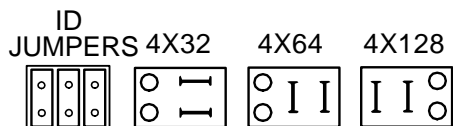

To set the correct ID code for 4x32, place two horizontally positioned jumpers in the right position, as shown below.

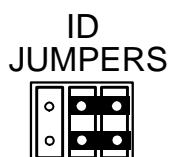

Placing CONFIG Jumpers on the 34934C-001 Configuration Block for 4x32 The CONFIG jumper area—shown below with jumpers removed—has an illustration to its right providing jumper placement guidance for the 4x32, 4x64 and 4x128 base matrix configurations.

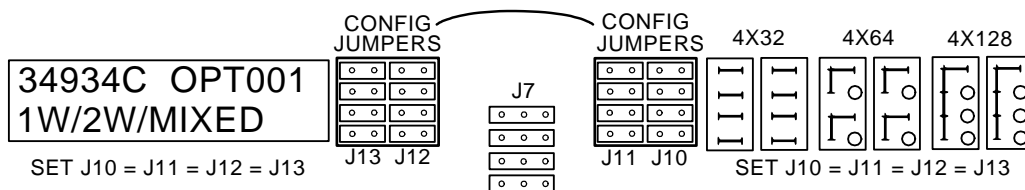

NOTE

The arc shown on the silk-screen—joining the two pairs of CONFIG JUMPER blocks—is a reminder that you *must* set all four blocks J10, J11, J12 and J13 identically.

For a base configuration of 4x32, place sixteen horizontally positioned jumpers as shown at right.

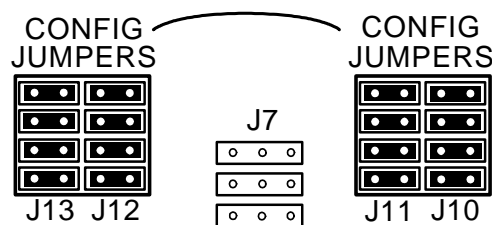

This board configuration “extends” the four row signals either left to connectors J5 and J6 or right to connectors J3 and J4, depending on the placement of jumpers in block J7. The row signals will also be extended to male D-Sub connectors P1 and P2, if “enabled” by placement of jumpers in block J8.

Placing Row Extension Jumpers on the 34934C-001 Configuration Block The jumpers in 16x3 jumper block J7 (at board center) determine if row connections can be made from the left or right side of the board (i.e. they “extend” the row signal connection points out to *only one* of the two pairs of blue 20-pin connectors at the sides of the configuration block).

Note that “row connections” at minimum include the connections between modules in the matrix, but may also include your access from field wiring to the matrix rows.

Setting these jumpers provides you the flexibility to plan how to route your custom cabling, depending on slot placement of the individual 34934A modules and their corresponding 34934C-001 blocks.

The following illustration shows the jumper block J7, along with the relevant guidance provided on the board’s silk-screen for jumper placement:

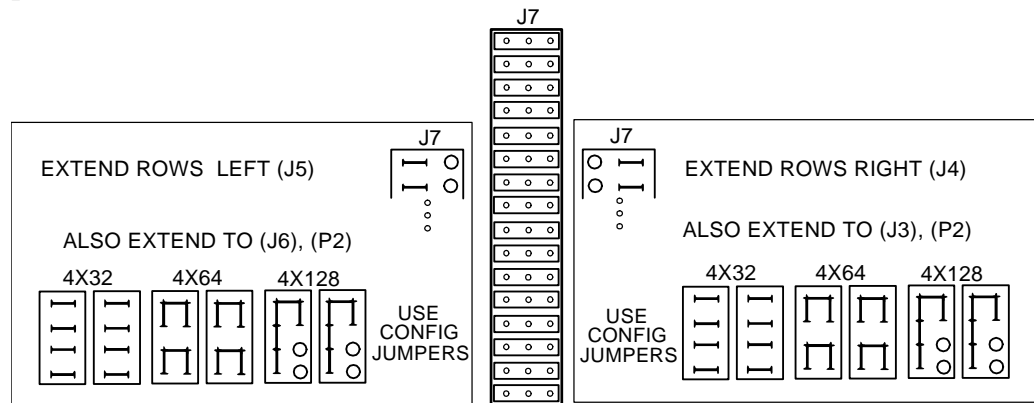

If you plan to extend rows *left*, to J5 and J6, place two 2x8 jumpers as shown at right.

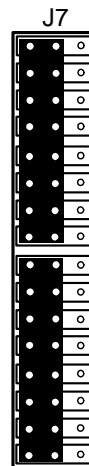

If you plan to extend rows *right*, to J3 and J4, place two 2x8 jumpers as shown at right.

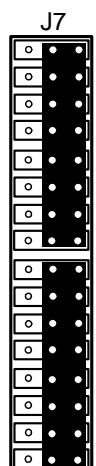

Placing Row Access Jumpers on the 34934C-001 Configuration Block The jumpers in 3x16 jumper block J8 (at lower board center) determine if row connections can be made from the two male D-Sub connectors P1 and P2 (i.e. they “enable” the row signal connection points at the D-subs).

These “row connections” are the traditional access points from field wiring to the matrix rows. In practice, your arrangement of test instrumentation and DUT test points will determine if you wish to make row connections at the D-subs, at the blue 20-pin connectors, or both.

Setting these jumpers provides you the flexibility to plan how to route your custom cabling.

The following illustration shows the jumper block J8, along with the relevant guidance provided on the board’s silk-screen for jumper placement:

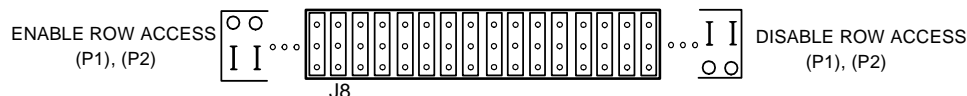

If you plan to connect row signals to the D-sub connectors, place two 2x8 jumpers as shown below.

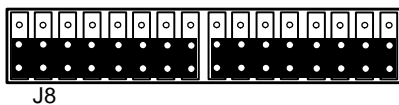

If you do not need to connect row signals to the D-sub connectors, place two 2x8 jumpers as shown below.

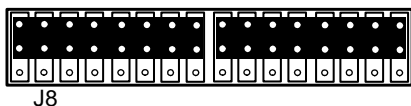

By not routing signals to the D-sub connectors, you avoid adding their extra capacitance.

Placing Safety Interlock Continuity Jumpers on the 34934C-001 Configuration Block

Block At each side of the configuration block are a pair of 20-pin extension headers. On the right side are labeled J3 and J4; on the left side are J5 and J6. In all cases, pins 19 and 20 are the safety interlock pins.

These headers provide for row extension and row signal access, depending on the placement of the jumpers in J7. You must have set the jumpers to extend rows either to the left or right side of the configuration block (see [“Placing Row Extension Jumpers on the 34934C-001 Configuration Block”](#) on page 40).

To provide continuity for the module’s safety interlock function, pins 19 and 20 on *both* extension headers on the selected side (left or right) must be shorted.

- For each of these headers, install one of the supplied keyed 20-pin terminators securely in that header, as shown below.

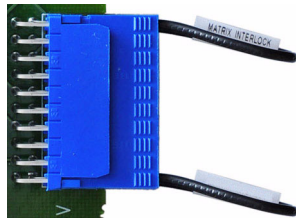

The supplied terminators incorporate both the shorting jumper for pins 19 and 20 and a jumper precluding connection to pins 1 and 2.

- The extension headers on the opposite side of the 34934C-001 do not require a safety interlock terminator; these will be hidden by the configuration block’s cover.

34934C-001 Configuration Block: Wiring

The next two subsections outline options for making row and column wiring connections to the configuration block.

Extension Header (Row Signal) Wiring to the 34934C-001

Below is an illustration of the possible locations for making row signal connections to the 34934T-001

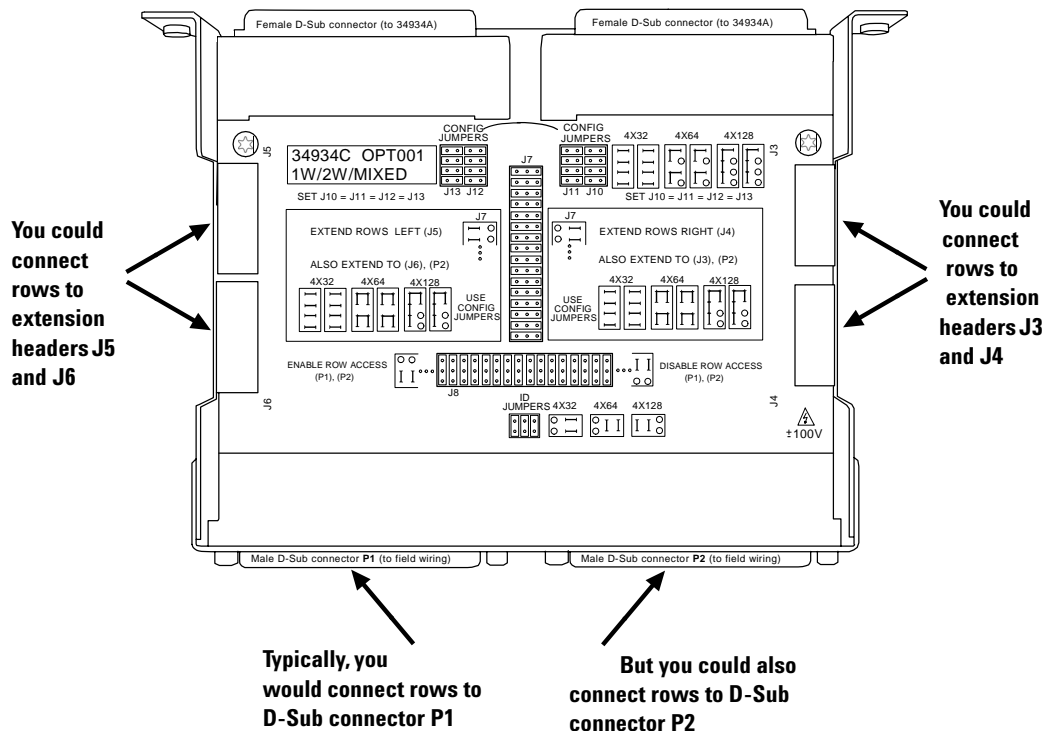

Typically, you could make both row and column connections to each module by fabricating custom cabling terminating in female D-Sub connectors. These attach to the configuration block's male D-Sub connectors P1 and P2.

Alternately, you may choose to connect only columns (typically test points on your DUT) to the D-Subs. There may be physical or electrical advantages in making your *row* connections (typically measurement devices) to the configuration block's blue extension connectors J3, J4, J5 and J6. To provide this flexibility, two extension headers are provided on each side of the configuration block.

You must have set the jumpers (in "Placing Row Extension Jumpers on the 34934C-001 Configuration Block" on page 40) to extend rows to two of the four headers. We'll call these the "live" headers.

In “Placing Safety Interlock Continuity Jumpers on the 34934C-001 Configuration Block” on page 42, you will have installed the supplied blue terminators in the live headers on the configuration block.

You can now make row connections to these headers, by utilizing the central 16 pins (3-18) on the snap-in terminators. The extension header’s supplied terminator is shown below. Pay careful attention to the polarizing notches for identification of pin 1:

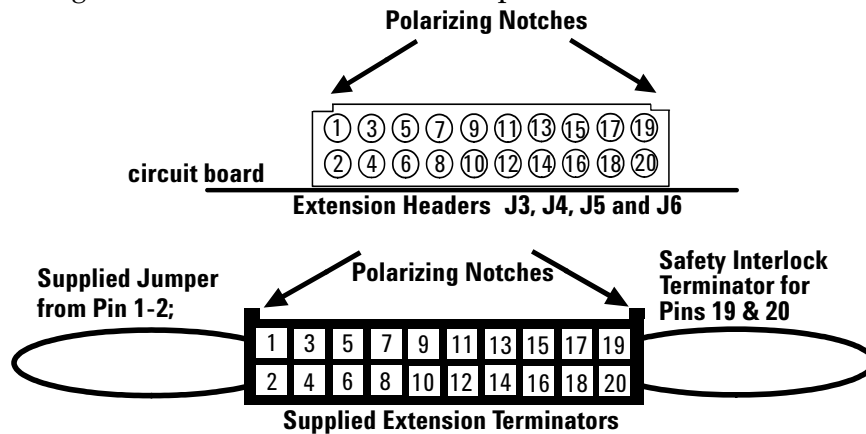

You must fabricate custom cabling to make row signal connections to the central 16 pins (3-18) of these headers, using the pin assignments below. The supplied blue terminators accommodate 22 AWG coated wire, fitted to “crimp-to-wire” contacts with latch tabs (FCI part #76357-301LF or equivalent).

34934C-001: Extension Header Pin Assignments for 4x32

Headers J4, J5				Headers J3, J6			
Description	Pin	Description	Pin	Description	Pin	Description	Pin
No Connect	1	No Connect	2	No Connect	1	No Connect	2
M1 R1H	3	M1 R1H	4	M2 R1H	3	M2 R1H	4
M1 R1L	5	M1 R1L	6	M2 R1L	5	M2 R1L	6
M1 R2H	7	M1 R2H	8	M2 R2H	7	M2 R2H	8
M1 R2L	9	M1 R2L	10	M2 R2L	9	M2 R2L	10
M1 R3H	11	M1 R3H	12	M2 R3H	11	M2 R3H	12
M1 R3L	13	M1 R3L	14	M2 R3L	13	M2 R3L	14
M1 R4H	15	M1 R4H	16	M2 R4H	15	M2 R4H	16
M1 R4L	17	M1 R4L	18	M2 R4L	17	M2 R4L	18
IL1	19	IL2	20	IL3	19	IL4	20

Note that each row signal (R1 through R4 (H,L) for each Matrix (1, 2) is routed out on two pins on the extension headers. You can make row signal connections to either row (upper, lower) of the connector.

If you are going to create an expanded-row matrix using multiple modules and configuration blocks, plan your wiring placement for each configuration block carefully, to allow for a daisy-chain interconnection between configuration blocks—in addition to any row wiring you may connect to the expansion headers. This interconnection is illustrated in “Arranging Multiple 34934A Modules with Configuration Blocks” on page 160.

34934C-001 D-Sub Connectors: Pin Assignments for 4x32 (base configuration)

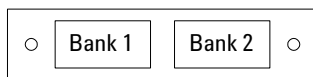

For orientation, the male D-sub connector end of the configuration block is facing you.

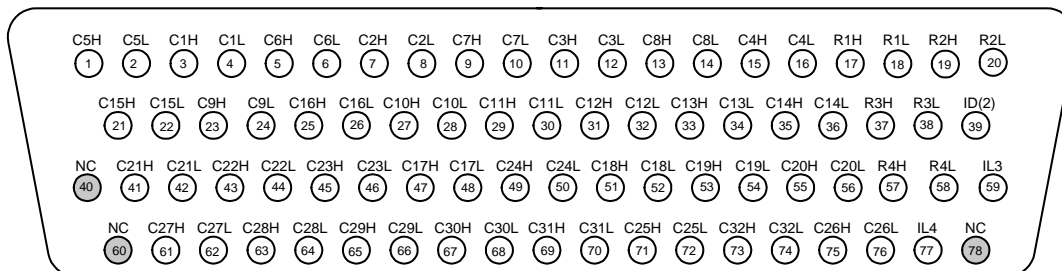

78-Pin D-Sub Male Connector
Bank 1 (P1)

Description	Pin	Description	Pin	Description	Pin	Description	Pin	Description	Pin	Description	Pin
R1H	17	C1H	3	C9H	23	C17H	47	C25H	71	ID2	39
R1L	18	C1L	4	C9L	24	C17L	48	C25L	72	IL3	59
R2H	19	C2H	7	C10H	27	C18H	51	C26H	75	IL4	77
R2L	20	C2L	8	C10L	28	C18L	52	C26L	76	No connect	40
R3H	37	C3H	11	C11H	29	C19H	53	C27H	61	No connect	60
R3L	38	C3L	12	C11L	30	C19L	54	C27L	62	No connect	78
R4H	57	C4H	15	C12H	31	C20H	55	C28H	63		
R4L	58	C4L	16	C12L	32	C20L	56	C28L	64		
		C5H	1	C13H	33	C21H	41	C29H	65		
		C5L	2	C13L	34	C21L	42	C29L	66		
		C6H	5	C14H	35	C22HL	43	C30H	67		
		C6L	6	C14L	36	C22L	44	C30L	68		
		C7H	9	C15H	21	C23H	45	C31H	69		
		C7L	10	C15L	22	C23L	46	C31L	70		
		C8H	13	C16H	25	C24H	49	C32H	73		
		C8L	14	C16L	26	C24L	50	C32L	74		

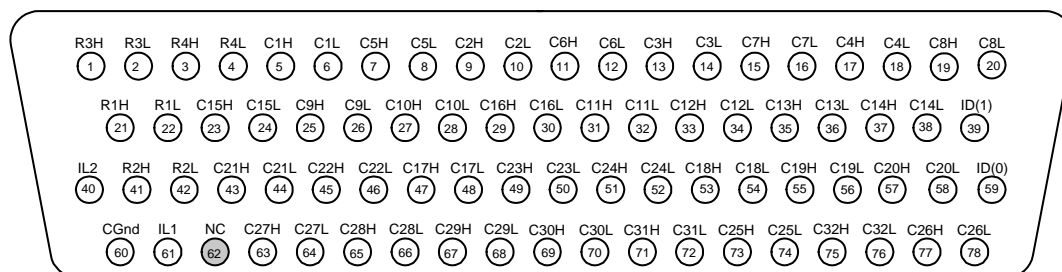

78-Pin D-Sub Male Connector
Bank 2 (P2)

Description	Pin	Description	Pin	Description	Pin	Description	Pin	Description	Pin	Description	Pin
R1H	21	C33H	5	C41H	25	C49H	47	C57H	73	ID1	39
R1L	22	C33L	6	C41L	26	C49L	48	C57L	74	ID0	59
R2H	41	C34H	9	C42H	27	C50H	53	C58H	77	IL1	61
R2L	42	C34L	10	C42L	28	C50L	54	C58L	78	IL2	40
R3H	1	C35H	13	C43H	31	C51H	55	C59H	63	Com Gnd	60
R3L	2	C35L	14	C43L	32	C51L	56	C59L	64	No connect	62
R4H	3	C36H	17	C44H	33	C52H	57	C60H	65		
R4L	4	C36L	18	C44L	34	C52L	58	C60L	66		
		C37H	7	C45H	35	C53H	43	C61H	67		
		C37L	8	C45L	36	C53L	44	C61L	68		
		C38H	11	C46H	37	C54H	45	C62H	69		
		C38L	12	C46L	38	C54L	46	C62L	70		
		C39H	15	C47H	23	C55H	49	C63H	71		
		C39L	16	C47L	24	C55L	50	C63L	72		
		C40H	19	C48H	29	C56H	51	C64H	75		
		C40L	20	C48L	30	C56L	52	C64L	76		

34934C-001 D-Sub Connectors: Safety Interlock Continuity Wiring for 4x32

While wiring to the 34934C-001's D-Sub connectors, you *must* make the following connections—in addition to the 4x32 row and column connections—to provide for safety interlock continuity:

Short: Pin 59 to Pin 77 on Bank 1

Short: Pin 40 to Pin 61 on Bank 2

Configuring a 4x32 Matrix by Direct Wiring

34934A module D-Sub Connectors: 4x32 Pin Assignments

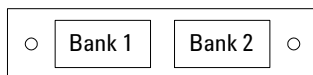

For orientation, the D-sub connector end of the module is facing you.

Connector and Pin Assignments for 4x32 Matrix 1H and Matrix 1L

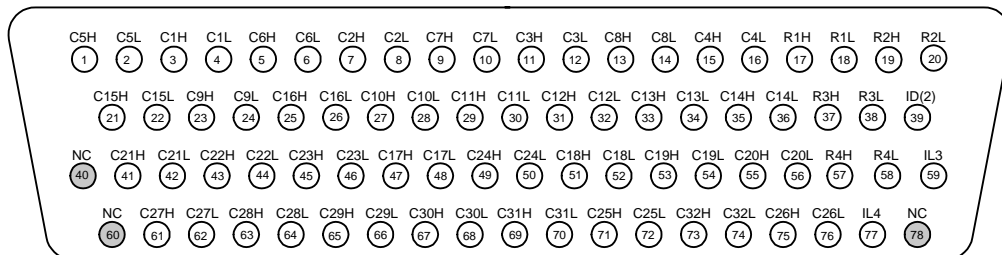

78-Pin D-Sub Male Connector

Bank 1

Description	Pin	Description	Pin	Description	Pin	Description	Pin	Description	Pin	Description	Pin
R1H	17	C1H	3	C9H	23	C17H	47	C25H	71	ID2	39
R1L	18	C1L	4	C9L	24	C17L	48	C25L	72	IL3	59
R2H	19	C2H	7	C10H	27	C18H	51	C26H	75	IL4	77
R2L	20	C2L	8	C10L	28	C18L	52	C26L	76	No connect	40
R3H	37	C3H	11	C11H	29	C19H	53	C27H	61	No connect	60
R3L	38	C3L	12	C11L	30	C19L	54	C27L	62	No connect	78
R4H	57	C4H	15	C12H	31	C20H	55	C28H	63		
R4L	58	C4L	16	C12L	32	C20L	56	C28L	64		
		C5H	1	C13H	33	C21H	41	C29H	65		
		C5L	2	C13L	34	C21L	42	C29L	66		
		C6H	5	C14H	35	C22H	43	C30H	67		
		C6L	6	C14L	36	C22L	44	C30L	68		
		C7H	9	C15H	21	C23H	45	C31H	69		
		C7L	10	C15L	22	C23L	46	C31L	70		
		C8H	13	C16H	25	C24H	49	C32H	73		
		C8L	14	C16L	26	C24L	50	C32L	74		

Connector and Pin Assignments for 4x32 Matrix 2H and Matrix 2L

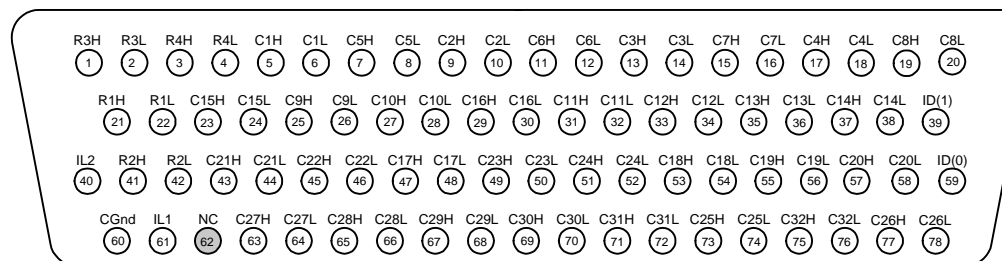

78-Pin D-Sub Male Connector

Bank 2

Description	Pin	Description	Pin	Description	Pin	Description	Pin	Description	Pin	Description	Pin
R1H	21	C1H	5	C9H	25	C17H	47	C25H	73	ID1	39
R1L	22	C1L	6	C9L	26	C17L	48	C25L	74	ID0	59
R2H	41	C2H	9	C10H	27	C18H	53	C26H	77	IL1	61
R2L	42	C2L	10	C10L	28	C18L	54	C26L	78	IL2	40
R3H	1	C3H	13	C11H	31	C19H	55	C27H	63	Com Gnd	60
R3L	2	C3L	14	C11L	32	C19L	56	C27L	64	No connect	62
R4H	3	C4H	17	C12H	33	C20H	57	C28H	65		
R4L	4	C4L	18	C12L	34	C20L	58	C28L	66		
		C5H	7	C13H	35	C21H	43	C29H	67		
		C5L	8	C13L	36	C21L	44	C29L	68		
		C6H	11	C14H	37	C22H	45	C30H	69		
		C6L	12	C14L	38	C22L	46	C30L	70		
		C7H	15	C15H	23	C23H	49	C31H	71		
		C7L	16	C15L	24	C23L	50	C31L	72		
		C8H	19	C16H	29	C24H	51	C32H	75		
		C8L	20	C16L	30	C24L	52	C32L	76		

34934A Module D-Sub Connectors: 4x32 Wiring

When wiring directly to the 34934A's D-Sub connectors, you *must* make the following connections—in addition to row and column connections—to configure the 4x32 matrix (matrices):

Module ID: The open pins listed below allow the 34980A mainframe to recognize the 4x32 matrix configuration.

Leave Open: Pin 39 on Bank 1 (ID bit 2)

Leave Open: Pin 39 on Bank 2 (ID bit 1)

Leave Open: Pin 59 on Bank 2 (ID bit 0)

Safety Interlock Continuity: The connections listed below provide for safety interlock continuity.

Short: Pin 59 to Pin 77 on Bank 1

Short: Pin 40 to Pin 61 on Bank 2

NOTE

If you use the 34934C-001 Configuration Block—in conjunction with the 34934A module—to make wiring connections, the additional **Module ID** connections are *not required*. Those connections are made within the hardware of the configuration block. You would need only make the **Safety Interlock Continuity** connections.

4x64 Matrix Configuration

To create a 4x64 matrix, you may connect your field wiring to the 34934A by three methods:

Terminal Block You can use terminal block 34934T-001. The terminal block connects to the 34934A's two D-Sub connectors; it provides 12 blocks of 12 screw terminals each and silk-screened guidance for field wiring the 4x64 matrices. Follow these sections in order to configure and wire the terminal block:

- “34934T-001 Terminal Block: 4x64 Layout” on page 50
- “34934T-001 Terminal Block: 4x64 Jumper Configuration” on page 52
- “34934T-001 Terminal Block: 4x64 Wiring” on page 54

Configuration Block You can use configuration block 34934C-001. Follow these sections in order to configure and wire the configuration block:

- “34934C-001 Configuration Block: Layout” on page 56
- “34934C-001 Configuration Block: 4x64 Jumper Configuration” on page 57
- “34934C-001 Configuration Block: Wiring” on page 63

NOTE

Use of the 34934C-001 precludes use of a piggy-backed 34934T-001 terminal block for field wiring connections; the combination is not mechanically reliable.

Direct Wiring You can wire directly to the module's D-Sub connectors using custom cabling. You will have to short specific pins on and between the D-Sub connectors to create the 4x64 configuration. Review *both* these sections *before* wiring to the module's D-Subs:

- “34934A D-Sub Connectors: 4x64 Pin Assignments” on page 67
- “34934A Module D-Sub Connectors: 4x64 Wiring” on page 68

Configuring a 4x64 Matrix using a Terminal Block

34934T-001 Terminal Block: 4x64 Layout

This terminal block with screw-type connections is labeled with the model number and the abbreviated module name. In addition, space is available on the label for you to write the slot number.

The *34980A Product Reference* CD (shipped with the module) contains a 34934T Wiring Log for you to document your wiring configuration for this module. You can open the wiring log file in Microsoft® Excel® or Adobe® Acrobat® format.

This terminal block's silk-screen shows the row and column terminals for the 4x64 matrix configuration:

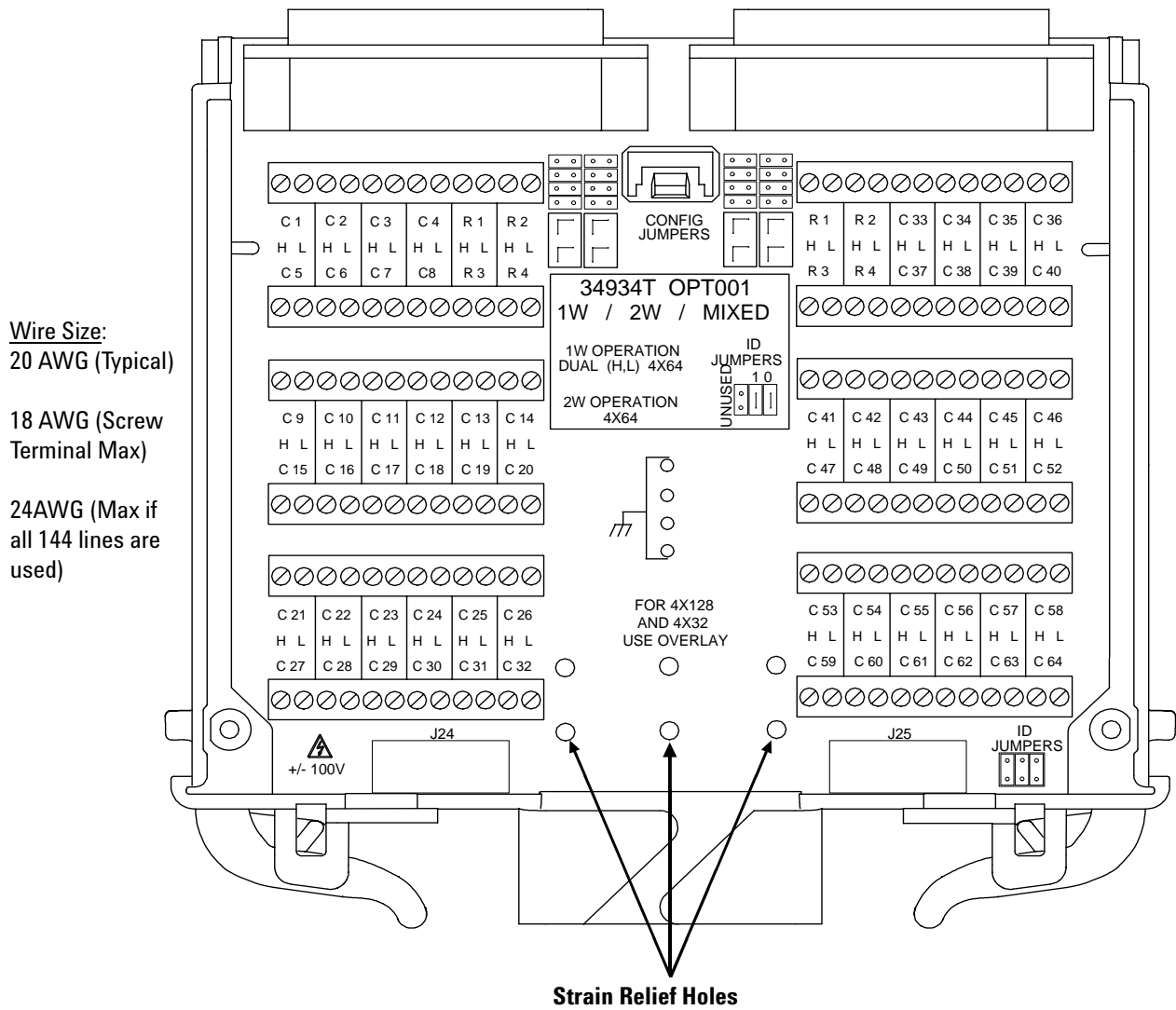

Note the six strain relief holes provided in the terminal block PCB. See the following page for instructions on providing wiring strain relief.

Terminal block strain relief

To reduce strain on the wiring at the terminals and maintain connection reliability, a strain relief feature has been incorporated into the terminal block design. Six holes have been placed near the lower edge of the circuit board, lined up with holes in the terminal block's bottom cover, as seen on “34934T-001 Terminal Block: 4x64 Layout” on page 50.

To use this feature:

- 1 Once all jumpers are installed and wiring is connected to the terminals, arrange the wires leading away from the terminal block in two bundles. This is easiest if the left bundle leads to the terminals on the left side of the block, and conversely for the right side.
- 2 Insert a cable tie (tie-wrap, zip-tie) down through each of the four outside holes in the PCB, continuing down through the holes in the terminal block's bottom cover.
- 3 Route these cable ties up through the center holes in the bottom cover and PCB.
- 4 Close and tighten the cable ties as required, and remove any excess so that it does not interfere with cover closure.

The completed bundles are shown below.

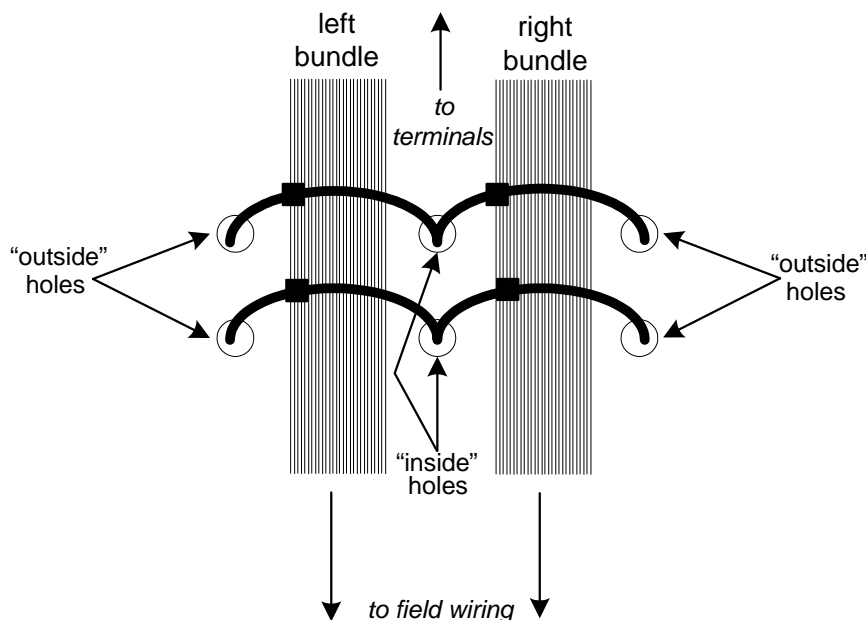

34934T-001 Terminal Block: 4x64 Jumper Configuration

This terminal block has three types of jumpers which must be connected to configure the 4x64 matrix (matrices):

- **CONFIG Jumpers:** place these 2-pin jumpers *identically on all four* 4x2 blocks of jumper pins located near the board's female D-Sub connectors, as shown.
- **ID Jumpers:** place these 2-pin jumpers on a 2x3 block of jumper pins on the lower right corner of the board, as shown.
- **Safety Interlock Continuity Jumpers:** place the supplied pre-wired terminators or equivalent custom wiring on the two 20-pin extension headers at the bottom of the terminal block, as shown.

Placing CONFIG Jumpers for 4x64 The CONFIG jumper area—shown below with jumpers removed—has an illustration below it (on the silk-screen) providing jumper placement guidance for 4x64 matrix configuration.

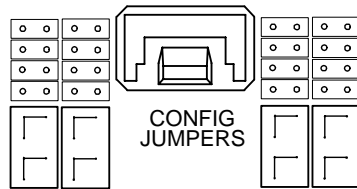

There are four 4x2 blocks of CONFIG JUMPER pins on either side of the board's center—you *must* set all four blocks identically.

- 1 Place eight vertically positioned jumpers as shown below.

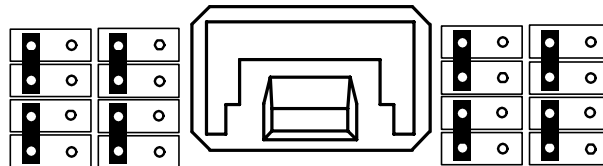

- 2 Then *stack* eight horizontally positioned jumpers *above* the first set of eight, as shown below.

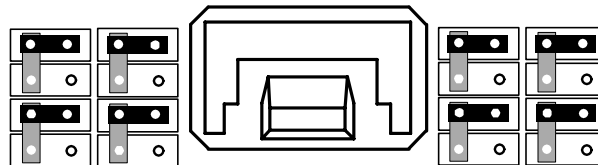

Placing ID Jumpers for 4x64 The ID jumpers allow the 34980A to recognize the 4x64 matrix configuration upon mainframe bootup. Jumper placement guidance is provided on the silk-screen (below left); the ID jumper block is shown at right with jumpers removed.

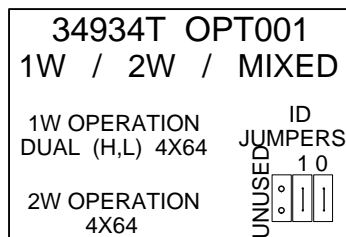

Location of placement guidance for ID Jumpers

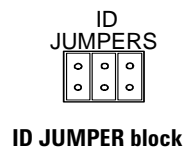

To set the correct ID code for 4x64, place two vertically positioned jumpers as shown below.

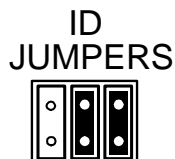

Placing Safety Interlock Continuity Jumpers for 4x64 At the bottom (end opposite the D-Sub connectors) of the terminal block are two 20-pin extension headers—marked J24 and J25 on the circuit board. These headers provide access to the module’s rows. Pins 19 and 20 on each header must be shorted to provide continuity for the module’s safety interlock function.

Two keyed 20-pin terminators are supplied for providing safety interlock continuity. Install the terminators securely in the headers, as shown below.

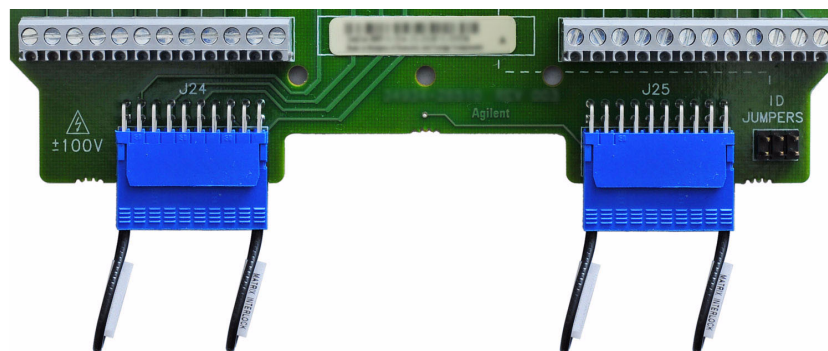

The supplied terminators incorporate both the shorting jumper for pins 19 and 20 and a jumper precluding connection to pins 1 and 2. Detailed pin diagrams for these terminators are provided on [page 56](#).

34934T-001 Terminal Block: 4x64 Wiring

Once the required jumpers have been placed to configure the terminal block as 4x64, you are ready to make row and column connections to the terminal block.

You may connect to the module's rows and columns by wiring to the screw terminals marked C1 through C64 (H, L) and R1 through R4 (H, L) on the silk-screen. The combined weight of these wires can create significant strain on the wiring; to minimize this see [“Terminal block strain relief”](#) on page 51.

However, you may prefer to use physically separate cabling for the row connections (e.g. if you connect your DUT to the columns and your measurement device(s) to the rows). The terminal block's extension headers J24 and J25 provide access to the rows; you can make row connections to the central 16 terminals (pins 3-18) on the supplied terminators you installed in [“Placing Safety Interlock Continuity Jumpers for 4x64”](#) on page 53.

Below is an illustration of the possible locations for making row signal connections to the 34934T-001:

You can connect row signals to the screw terminals here...

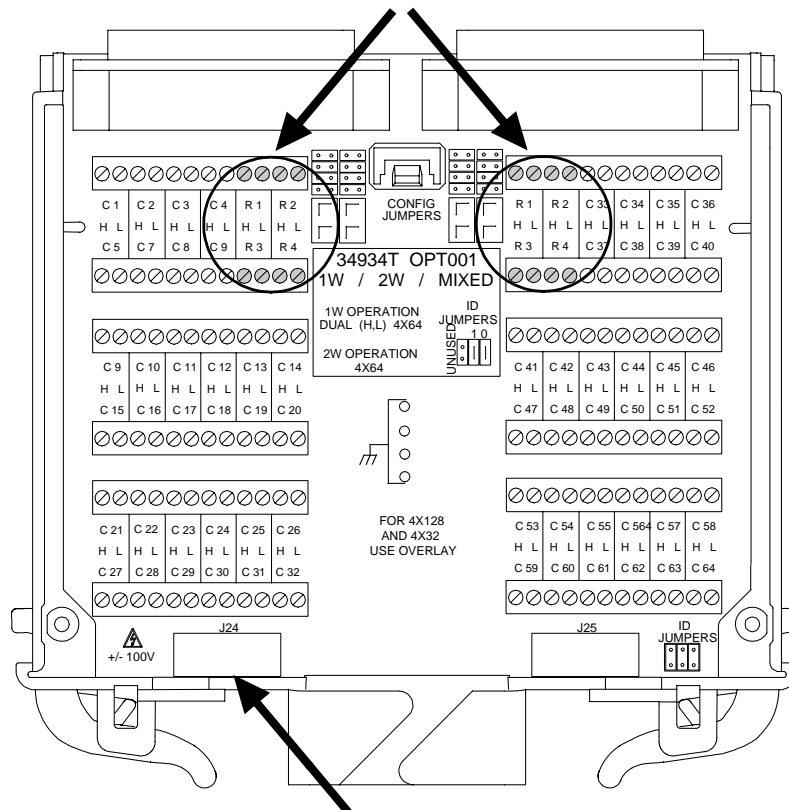

...or to the central 16 pins of extension header J24 here.

The following subsection outlines how to make row connections to extension header J24.

Extension Header (Row Signal) Wiring for 4x64

The position of extension headers J24 and J25 are marked on the 34934T-001's silk-screen. Oriented with the terminal side of the board up, the pin numbers for these headers are shown below.

Extension Headers J24 and J25

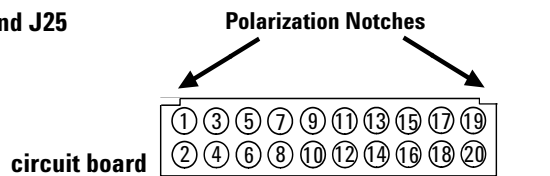

The supplied 20-pin terminators are identical. For 4x64, you can only make row connections to header J24. The terminal numbers—corresponding to the headers—are shown below. *Pay careful attention to the indexing keys on the connectors, to correctly identify terminal #1.*

20-Pin Terminators for J24 and J25

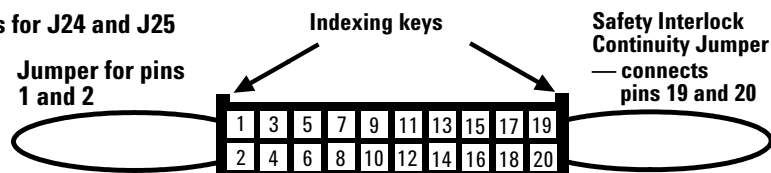

You must fabricate custom cabling to make row signal connections to the central 16 pins (3-18) of header J24, using the pin assignments below. The supplied blue terminators accommodate 22 AWG coated wire, fitted to “crimp-to-wire” contacts with latch tabs (FCI part #76357-301LF or equivalent).

34934T-001: Extension Header Pin Assignments for 4x64

Header J24				Header J25			
Description	Pin	Description	Pin	Description	Pin	Description	Pin
No connect	1	No connect	2	No connect	1	No connect	2
R1H	3	R1H	4	No connect	3	No connect	4
R1L	5	R1L	6	No connect	5	No connect	6
R2H	7	R2H	8	No connect	7	No connect	8
R2L	9	R2L	10	No connect	9	No connect	10
R3H	11	R3H	12	No connect	11	No connect	12
R3L	13	R3L	14	No connect	13	No connect	14
R4H	15	R4H	16	No connect	15	No connect	16
R4L	17	R4L	18	No connect	17	No connect	18
IL1	19	IL2	20	IL3	19	IL4	20

Note that each row signal (R1 through R4 (H,L) is routed out on two pins on J24. You can make row signal connections to either row (upper, lower) of the connector.

If you are going create an expanded-row matrix using multiple modules and terminal blocks, plan your wiring placement for each terminal block carefully, to allow for a daisy-chain interconnection between terminal blocks—in addition to any row wiring you may connect to the expansion headers. This interconnection is illustrated in “[Arranging Multiple 34934A Modules with Terminal Blocks](#)” on page 158.

Configuring a 4x64 Matrix using a Configuration Block

34934C-001 Configuration Block: Layout

This configuration block is labeled with the model number and the abbreviated module name.

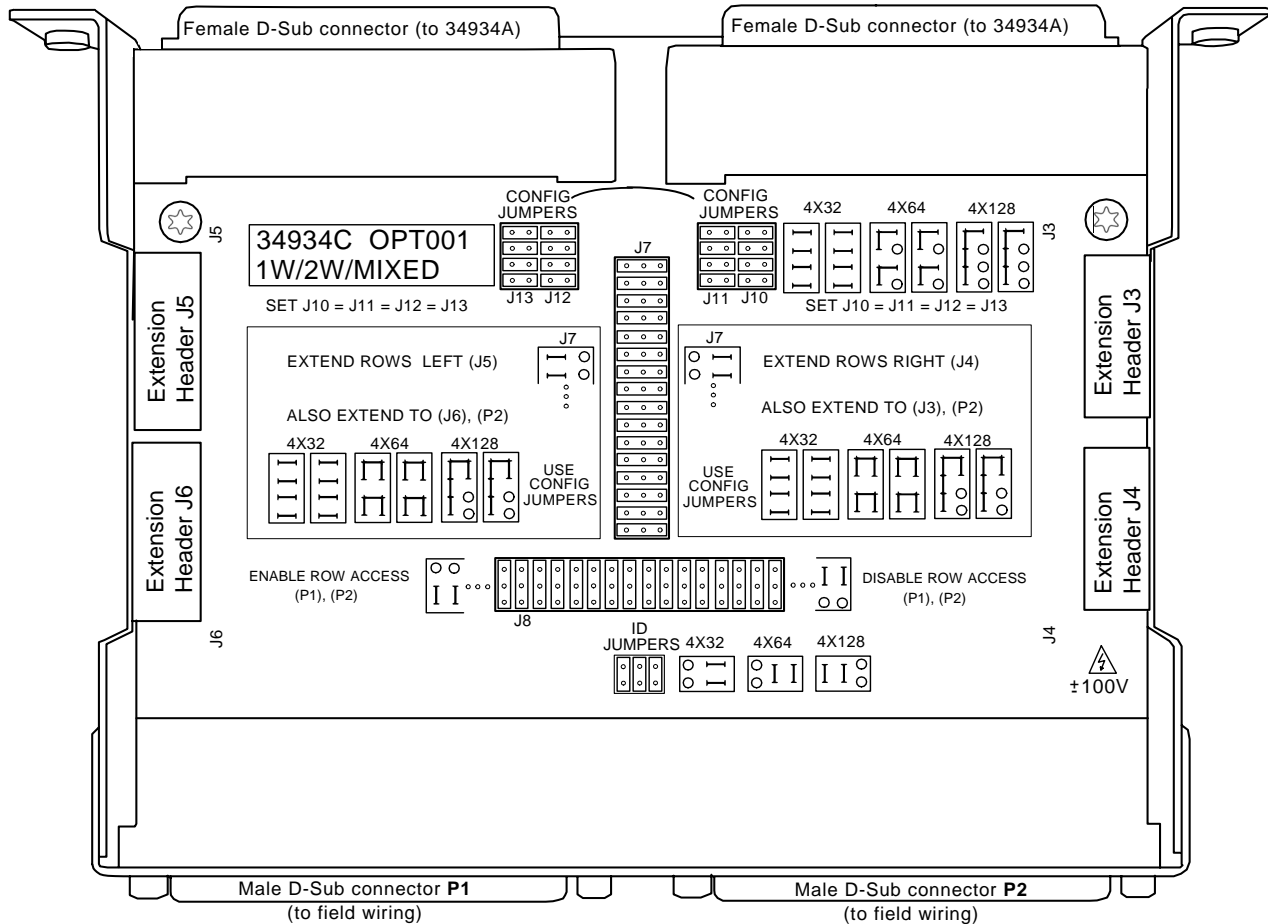

Note four types of on-board jumpers you'll have to set to configure this board; some will be familiar from the configuration descriptions of the *terminal blocks*, but some are new. Instructions for setting these are provided in "[34934C-001 Configuration Block: 4x64 Jumper Configuration](#)" on page 57.

- ID Jumpers
- CONFIG Jumpers (J10, J11, J12 and J13)
- Row Extension Jumpers (J7)
- Row Access Jumpers (J8)

Also note the four extension headers (J3, J4, J5 and J6). Instructions for wiring to these are provided in "[34934C-001 Configuration Block: Wiring](#)" on page 63.

34934C-001 Configuration Block: 4x64 Jumper Configuration

The configuration block has five types of jumpers which must be connected to configure it for use in an expanded 4-row matrix. In this section, you will place:

- **ID Jumpers:** place these 2-pin jumpers on a 2x3 block of jumper pins near the bottom center of the board. See [“Placing ID Jumpers on the 34934C-001 Configuration Block for 4x64”](#) on page 58.
- **CONFIG Jumpers:** place these 2-pin jumpers *identically on all four* 4x2 blocks of jumper pins located near the board’s female D-Sub connectors. See [“Placing CONFIG Jumpers on the 34934C-001 Configuration Block for 4x64”](#) on page 59.
- **Row Extension Jumpers:** place these 16-pin jumpers on a 16x3 block (J7) of jumper pins at the board’s center. See [“Placing Row Extension Jumpers on the 34934C-001 Configuration Block”](#) on page 60.
- **Row Access Jumpers:** place these 16-pin jumpers on a 3x16 block of jumper pins located just above the ID Jumpers. See [“Placing Row Access Jumpers on the 34934C-001 Configuration Block”](#) on page 61.
- **Safety Interlock Continuity Jumpers:** place the supplied pre-wired terminators on the four 20-pin extension headers at the sides of the configuration block. See [“Placing Safety Interlock Continuity Jumpers on the 34934C-001 Configuration Block”](#) on page 62.

Placing ID Jumpers on the 34934C-001 Configuration Block for 4x64 The ID jumpers allow the 34980A to recognize the base matrix configuration used by the 34934C-001, upon mainframe bootup. The ID jumpers are placed in a 2x3 jumper block, located below jumper block J8. Jumper placement guidance is provided on the configuration block's silk-screen, to the right of the jumpers:

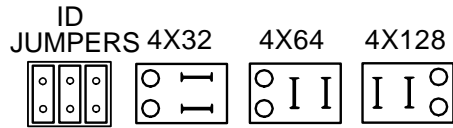

To set the correct ID code for 4x64, place two vertically positioned jumpers in the right position, as shown below.

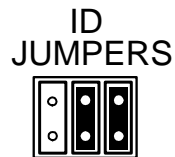

Placing CONFIG Jumpers on the 34934C-001 Configuration Block for 4x64 The CONFIG jumper area—shown below with jumpers removed—has an illustration to its right providing jumper placement guidance for the 4x32, 4x64 and 4x128 base matrix configurations.

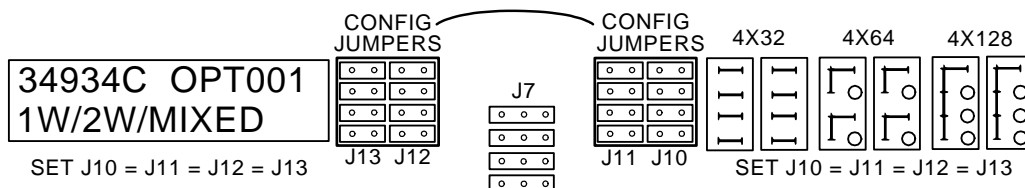

To set the CONFIG jumpers for 4x64:

1 Place eight horizontally positioned jumpers as shown at right.

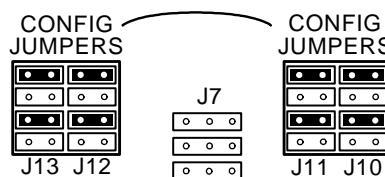

2 Then stack eight vertically positioned jumpers above the first set, as shown at right.

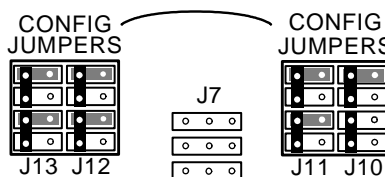

This board configuration (through step 2) “extends” the four row signals either left to connector J5 or right to connector J4, depending on the placement of jumpers in block J7. The row signals will also be extended to male D-Sub connector P1, if “enabled” by placement of jumpers in block J8. *This provides typical row connectivity options.*

3 **Optional Step:** For the 4x64 base configuration, *additional* jumpers must be placed to provide the following additional options for row connectivity:

- extend the row signals either left to connector J6 or right to connector J3, depending on the placement of jumpers in block J7.
- extend the row signals to male D-Sub connector P2, if “enabled” by placement of jumpers in block J8.

If these additional row connectivity options are desired, stack eight additional vertically positioned jumpers as shown at right.

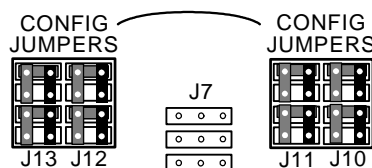

This optional step is implied by the silk-screened guidance provided on the board at either side of jumper block J7, illustrated below.

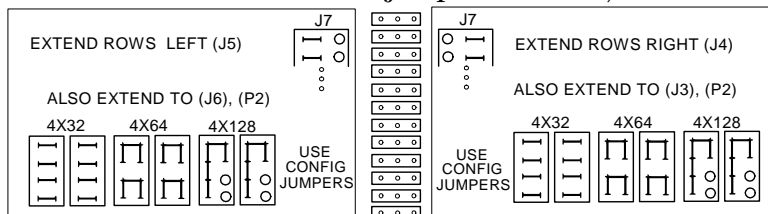

Placing Row Extension Jumpers on the 34934C-001 Configuration Block The jumpers in 16x3 jumper block J7 (at board center) determine if row connections can be made from the left or right side of the board (i.e. they “extend” the row signal connection points out to *only one* of the two pairs of blue 20-pin connectors at the sides of the configuration block).

Note that “row connections” at minimum include the connections between modules in the matrix, but may also include your access from field wiring to the matrix rows.

Setting these jumpers provides you the flexibility to plan how to route your custom cabling, depending on slot placement of the individual 34934A modules and their corresponding 34934C-001 blocks.

The following illustration shows the jumper block J7, along with the relevant guidance provided on the board’s silk-screen for jumper placement:

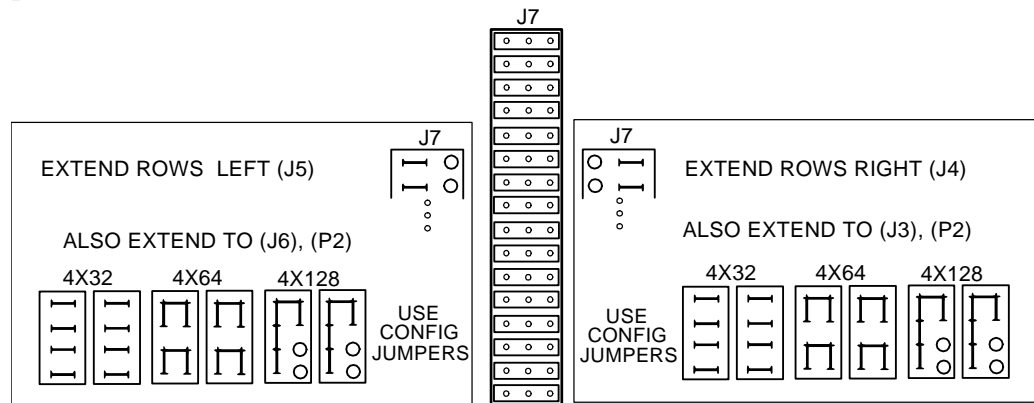

If you plan to extend rows *left*, to J5 and J6, place two 2x8 jumpers as shown at right.

The row signals will also be present on J6 *if* you placed the optional CONFIG jumpers in step 3 on [page 59](#).

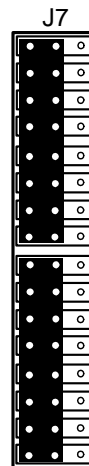

If you plan to extend rows *right*, to J3 and J4, place two 2x8 jumpers as shown at right.

The row signals will also be present on J3 *if* you placed the optional CONFIG jumpers in step 3 on [page 59](#).

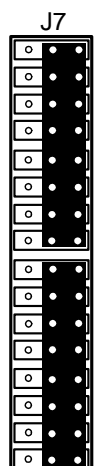

Placing Row Access Jumpers on the 34934C-001 Configuration Block The jumpers in 3x16 jumper block J8 (at lower board center) determine if row connections can be made from the two male D-Sub connectors P1 and P2 (i.e. they “enable” the row signal connection points at the D-subs).

These “row connections” are the traditional access points from field wiring to the matrix rows. In practice, your arrangement of test instrumentation and DUT test points will determine if you wish to make row connections at the D-subs, at the blue 20-pin connectors, or both.

Setting these jumpers provides you the flexibility to plan how to route your custom cabling.

The following illustration shows the jumper block J8, along with the relevant guidance provided on the board’s silk-screen for jumper placement:

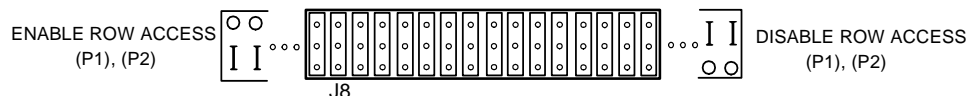

If you plan to connect row signals to the D-sub connectors, place two 2x8 jumpers as shown below.

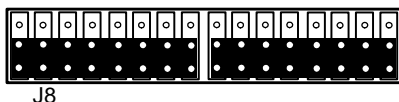

If you do not need to connect row signals to the D-sub connectors, place two 2x8 jumpers as shown below.

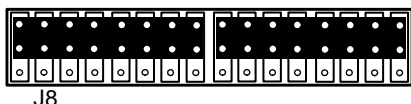

By not routing signals to the D-sub connectors, you avoid adding their extra capacitance.

Placing Safety Interlock Continuity Jumpers on the 34934C-001 Configuration Block

Block At each side of the configuration block are a pair of 20-pin extension headers. On the right side are labeled J3 and J4; on the left side are J5 and J6. In all cases, pins 19 and 20 are the safety interlock pins.

These headers provide for row extension and row signal access, depending on the placement of the jumpers in J7. You must have set the jumpers to extend rows either to the left or right side (of the configuration block) (see “[Placing Row Extension Jumpers on the 34934C-001 Configuration Block](#)” on page 60).

To provide continuity for the module’s safety interlock function, pins 19 and 20 on *both* extension headers on the selected side (left or right) must be shorted.

- For each of these headers, install one of the supplied keyed 20-pin terminators securely in that header, as shown below.

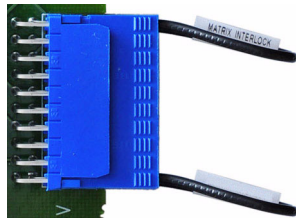

The supplied terminators incorporate both the shorting jumper for pins 19 and 20 and a jumper precluding connection to pins 1 and 2.

- The extension headers on the opposite side of the 34934C-001 do not require a safety interlock terminator; these will be hidden by the configuration block’s cover.

34934C-001 Configuration Block: Wiring

The next two subsections outline options for making row and column wiring connections to the configuration block.

Extension Header (Row Signal) Wiring to the 34934C-001

Below is an illustration of the possible locations for making row signal connections to the 34934T-001

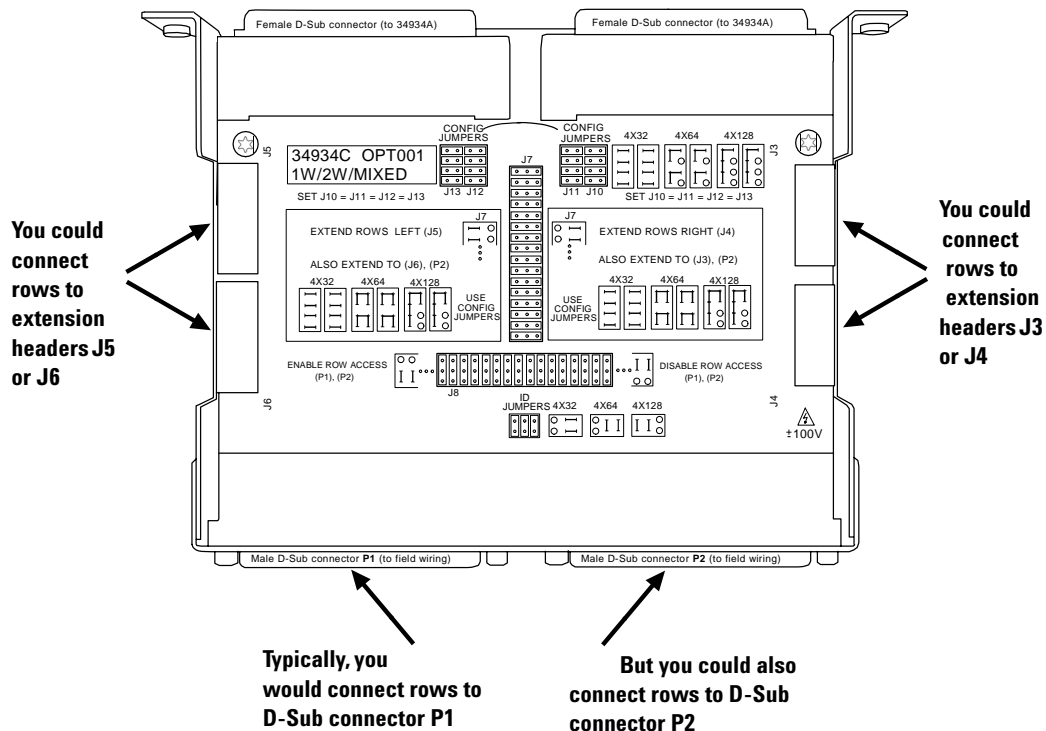

Typically, you could make both row and column connections to each module by fabricating custom cabling terminating in female D-Sub connectors. These attach to the configuration block's male D-Sub connectors P1 and P2.

Alternately, you may choose to connect only columns (typically test points on your DUT) to the D-Subs. There may be physical or electrical advantages in making your *row* connections (typically measurement devices) to the configuration block's blue extension connectors J3, J4, J5 and J6. To provide this flexibility, two extension headers are provided on each side of the configuration block.

You must have set the jumpers (in ["Placing Row Extension Jumpers on the 34934C-001 Configuration Block"](#) on page 60) to extend rows to two of the four headers. We'll call these the "live" headers.

Had you created *two* live headers, by performing step 3 on [page 59](#); then the second header (J3 or J6) on the side selected by jumpers J7 will also be a live header.

In “Placing Safety Interlock Continuity Jumpers on the 34934C-001 Configuration Block” on page 62, you will have installed the supplied blue terminators in the live headers on the configuration block.

You can now make row connections to these headers, by utilizing the central 16 pins (3-18) on the snap-in terminators. The extension header’s supplied terminator is shown below. Pay careful attention to the polarizing notches for identification of pin 1:

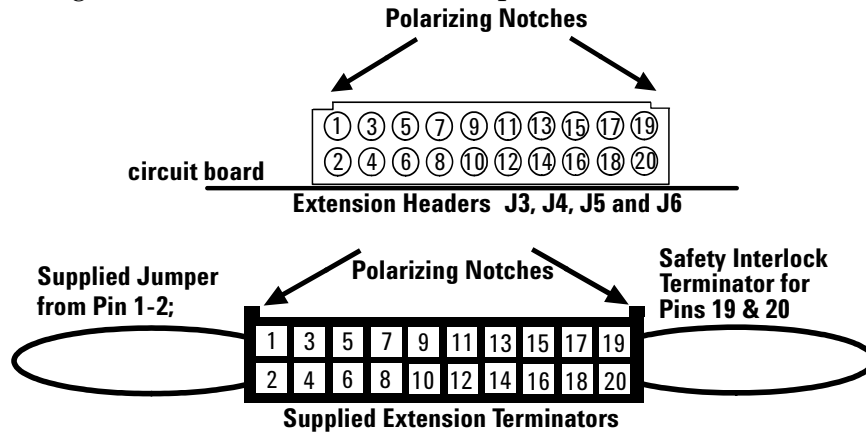

34934C-001: Extension Header Pin Assignments for 4x64

Headers J4, J5				Headers J3, J6			
Description	Pin	Description	Pin	Description	Pin	Description	Pin
No Connect	1	No Connect	2	No Connect	1	No Connect	2
R1H	3	R1H	4	R1H	3	R1H	4
R1L	5	R1L	6	R1L	5	R1L	6
R2H	7	R2H	8	R2H	7	R2H	8
R2L	9	R2L	10	R2L	9	R2L	10
R3H	11	R3H	12	R3H	11	R3H	12
R3L	13	R3L	14	R3L	13	R3L	14
R4H	15	R4H	16	R4H	15	R4H	16
R4L	17	R4L	18	R4L	17	R4L	18
IL1	19	IL2	20	IL3	19	IL4	20

If you are going to create an expanded-row matrix using multiple modules and configuration blocks, plan your wiring placement for each configuration block carefully, to allow for a daisy-chain interconnection between configuration blocks—in addition to any row wiring you may connect to the expansion headers. This interconnection is illustrated in “Arranging Multiple 34934A Modules with Configuration Blocks” on page 160.

34934C-001 D-Sub Connectors: Pin Assignments for 4x64 (base configuration)

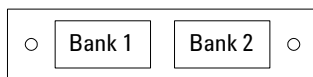

For orientation, the male D-sub connector end of the configuration block is facing you.

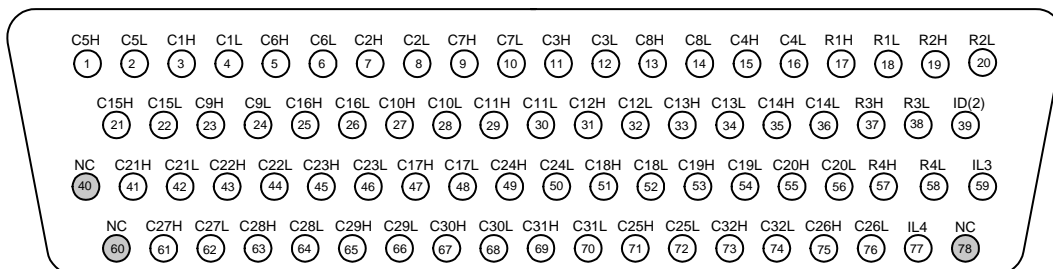

78-Pin D-Sub Male Connector
Bank 1 (P1)

Description	Pin	Description	Pin	Description	Pin	Description	Pin	Description	Pin	Description	Pin
R1H	17	C1H	3	C9H	23	C17H	47	C25L	71	ID2	39
R1L	18	C1L	4	C9L	24	C17L	48	C25L	72	IL3	59
R2H	19	C2H	7	C10H	27	C18H	51	C26L	75	IL4	77
R2L	20	C2L	8	C10L	28	C18L	52	C26L	76	No connect	40
R3H	37	C3H	11	C11H	29	C19H	53	C27L	61	No connect	60
R3L	38	C3L	12	C11L	30	C19L	54	C27L	62	No connect	78
R4H	57	C4H	15	C12H	31	C20H	55	C28L	63		
R4L	58	C4L	16	C12L	32	C20L	56	C28L	64		
		C5H	1	C13H	33	C21L	41	C29L	65		
		C5L	2	C13L	34	C21L	42	C29L	66		
		C6H	5	C14H	35	C22L	43	C30L	67		
		C6L	6	C14L	36	C22L	44	C30L	68		
		C7H	9	C15H	21	C23L	45	C31L	69		
		C7L	10	C15L	22	C23L	46	C31L	70		
		C8H	13	C16H	25	C24L	49	C32L	73		
		C8L	14	C16L	26	C24L	50	C32L	74		

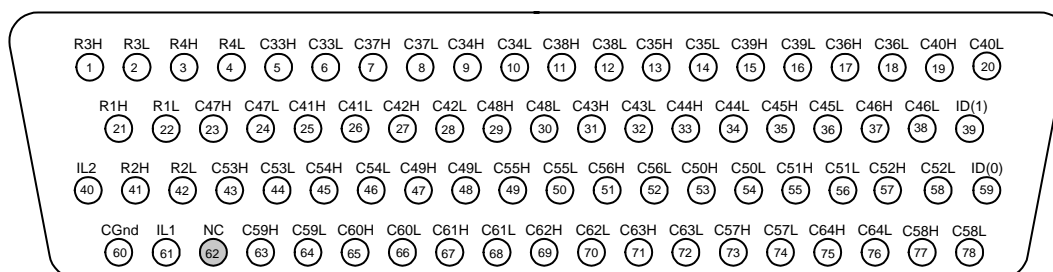

78-Pin D-Sub Male Connector
Bank 2 (P2)

Description	Pin	Description	Pin	Description	Pin	Description	Pin	Description	Pin	Description	Pin
R1H	21	C33H	5	C41H	25	C49H	47	C57H	73	ID1	39
R1L	22	C33L	6	C41L	26	C49L	48	C57L	74	ID0	59
R2H	41	C34H	9	C42H	27	C50H	53	C58H	77	IL1	61
R2L	42	C34L	10	C42L	28	C50L	54	C58L	78	IL2	40
R3H	1	C35H	13	C43H	31	C51H	55	C59H	63	Com Gnd	60
R3L	2	C35L	14	C43L	32	C51L	56	C59L	64	No connect	62
R4H	3	C36H	17	C44H	33	C52H	57	C60H	65		
R4L	4	C36L	18	C44L	34	C52L	58	C60L	66		
		C37H	7	C45H	35	C53H	43	C61H	67		
		C37L	8	C45L	36	C53L	44	C61L	68		
		C38H	11	C46H	37	C54H	45	C62H	69		
		C38L	12	C46L	38	C54L	46	C62L	70		
		C39H	15	C47H	23	C55H	49	C63H	71		
		C39L	16	C47L	24	C55L	50	C63L	72		
		C40H	19	C48H	29	C56H	51	C64H	75		
		C40L	20	C48L	30	C56L	52	C64L	76		

34934C-001 D-Sub Connectors: Safety Interlock Continuity Wiring for 4x64

While wiring to the 34934C-001's D-Sub connectors, you *must* make the following connections—in addition to the 4x64 row and column connections—to provide for safety interlock continuity:

Short: Pin 59 to Pin 77 on Bank 1

Short: Pin 40 to Pin 61 on Bank 2

Configuring a 4x64 Matrix by Direct Wiring

34934A D-Sub Connectors: 4x64 Pin Assignments

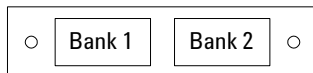

For orientation, the D-sub connector end of the module is facing you.

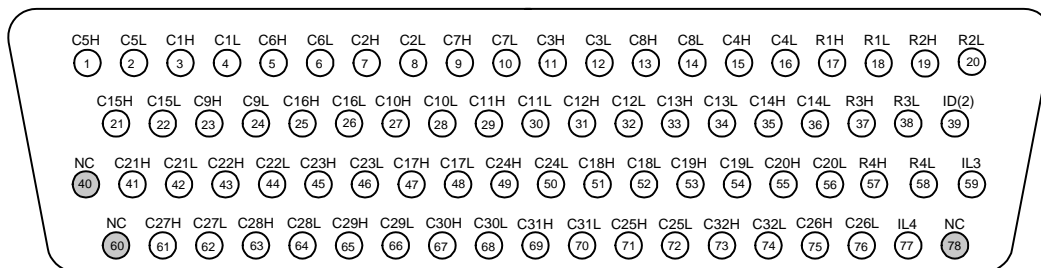

78-Pin D-Sub Male Connector

Bank 1

Description	Pin	Description	Pin	Description	Pin	Description	Pin	Description	Pin	Description	Pin
R1H	17	C1H	3	C9H	23	C17H	47	C25H	71	ID2	39
R1L	18	C1L	4	C9L	24	C17L	48	C25L	72	IL3	59
R2H	19	C2H	7	C10H	27	C18H	51	C26H	75	IL4	77
R2L	20	C2L	8	C10L	28	C18L	52	C26L	76	No connect	40
R3H	37	C3H	11	C11H	29	C19H	53	C27H	61	No connect	60
R3L	38	C3L	12	C11L	30	C19L	54	C27L	62	No connect	78
R4H	57	C4H	15	C12H	31	C20H	55	C28H	63		
R4L	58	C4L	16	C12L	32	C20L	56	C28L	64		
		C5H	1	C13H	33	C21H	41	C29H	65		
		C5L	2	C13L	34	C21L	42	C29L	66		
		C6H	5	C14H	35	C22H	43	C30H	67		
		C6L	6	C14L	36	C22L	44	C30L	68		
		C7H	9	C15H	21	C23H	45	C31H	69		
		C7L	10	C15L	22	C23L	46	C31L	70		
		C8H	13	C16H	25	C24H	49	C32H	73		
		C8L	14	C16L	26	C24L	50	C32L	74		

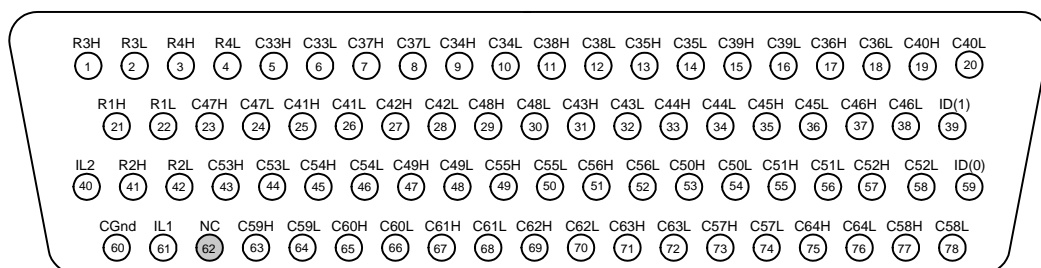

78-Pin D-Sub Male Connector

Bank 2

Description	Pin	Description	Pin	Description	Pin	Description	Pin	Description	Pin	Description	Pin
R1H	21	C33H	5	C41H	25	C49H	47	C57H	73	ID1	39
R1L	22	C33L	6	C41L	26	C49L	48	C57L	74	ID0	59
R2H	41	C34H	9	C42H	27	C50H	53	C58H	77	IL1	61
R2L	42	C34L	10	C42L	28	C50L	54	C58L	78	IL2	40
R3H	1	C35H	13	C43H	31	C51H	55	C59H	63	Com Gnd	60
R3L	2	C35L	14	C43L	32	C51L	56	C59L	64	No connect	62
R4H	3	C36H	17	C44H	33	C52H	57	C60H	65		
R4L	4	C36L	18	C44L	34	C52L	58	C60L	66		
		C37H	7	C45H	35	C53H	43	C61H	67		
		C37L	8	C45L	36	C53L	44	C61L	68		
		C38H	11	C46H	37	C54H	45	C62H	69		
		C38L	12	C46L	38	C54L	46	C62L	70		
		C39H	15	C47H	23	C55H	49	C63H	71		
		C39L	16	C47L	24	C55L	50	C63L	72		
		C40H	19	C48H	29	C56H	51	C64H	75		
		C40L	20	C48L	30	C56L	52	C64L	76		

34934A Module D-Sub Connectors: 4x64 Wiring

When wiring directly to the 34934A's D-Sub connectors, you *must* make the following connections—in addition to row and column connections—to configure the 4x64 matrix (matrices):

Module Configuration: The connections listed below short the pairs of rows in the 34934A's native 4x4x32 configuration to create the 4x64 MH and 4x64 ML matrices.

Short: Pin 17 on Bank 1 to Pin 21 on Bank 2
 Short: Pin 18 on Bank 1 to Pin 22 on Bank 2
 Short: Pin 19 on Bank 1 to Pin 41 on Bank 2
 Short: Pin 20 on Bank 1 to Pin 42 on Bank 2
 Short: Pin 37 on Bank 1 to Pin 1 on Bank 2
 Short: Pin 38 on Bank 1 to Pin 2 on Bank 2
 Short: Pin 57 on Bank 1 to Pin 3 on Bank 2
 Short: Pin 58 on Bank 1 to Pin 4 on Bank 2

Note that these connections require wires run *between* the two D-Sub connectors. You may make these connections near your test instrumentation or DUT, or near the D-Sub ends of your custom cabling.

Module ID: The connections listed below allow the 34980A mainframe to recognize the 4x64 matrix configuration.

Leave Open: Pin 39 on Bank 1 (ID bit 2)
 Ground: Pin 39 on Bank 2 (ID bit 1)
 Ground: Pin 59 on Bank 2 (ID bit 0)

Safety Interlock Continuity: The connections listed below provide for safety interlock continuity.

Short: Pin 59 to Pin 77 on Bank 1
 Short: Pin 40 to Pin 61 on Bank 2

NOTE

If you use the 34934C-001 Configuration Block—in conjunction with the 34934A module—to make wiring connections, the additional **Module Configuration** and **Module ID** connections are *not required*. Those connections are made within the hardware of the configuration block. You would need only make the **Safety Interlock Continuity** connections.

4x128 Matrix Configuration

To create a 4x128 matrix, you may connect your field wiring to the 34934A by three methods:

Terminal Block You can use terminal block 34934T-001. The terminal block connects to the 34934A's two D-Sub connectors; it provides 12 blocks of 12 screw terminals each and a *4x128 removable overlay* (supplied with the 34934T-001) which provides guidance for field wiring the 4x128 matrices. Follow these sections in order to configure and wire the terminal block:

- “34934T-001 Terminal Block: 4x128 Layout” on page 70
- “34934T-001 Terminal Block: 4x128 Jumper Configuration” on page 72
- “34934T-001 Terminal Block: 4x128 Wiring” on page 74

Configuration Block You can use configuration block 34934C-001. Follow these sections in order to configure and wire the configuration block:

- “34934C-001 Configuration Block: Layout” on page 76
- “34934C-001 Configuration Block: 4x128 Jumper Configuration” on page 77
- “34934C-001 Configuration Block: Wiring” on page 83

NOTE

Use of the 34934C-001 precludes use of a piggy-backed 34934T-001 terminal block for field wiring connections; the combination is not mechanically reliable.

Direct Wiring You can wire directly to the module's D-Sub connectors using custom cabling. You will have to short specific pins on and between the D-Sub connectors to create the 4x128 configuration. Review *both* these sections *before* wiring to the module's D-Subs:

- “34934A D-Sub Connectors: 4x128 Pin Assignments” on page 87
- “34934A Module D-Sub Connectors: 4x128 Wiring” on page 88

Configuring a 4x128 Matrix using a Terminal Block

34934T-001 Terminal Block: 4x128 Layout

This terminal block with screw-type connections is labeled with the model number and the abbreviated module name. In addition, space is available on the label for you to write the slot number.

The *34980A Product Reference* CD (shipped with the module) contains a 34934T Wiring Log for you to document your wiring configuration for this module. You can open the wiring log file in Microsoft® Excel® or Adobe® Acrobat® format.

This terminal block's *4x128 removable overlay* shows the row and column terminals for the 4x128 matrix configuration:

Wire Size:
20 AWG Typical)

18 AWG (Screw
Terminal Max)

24AWG (Max if
all 144 lines are
used)

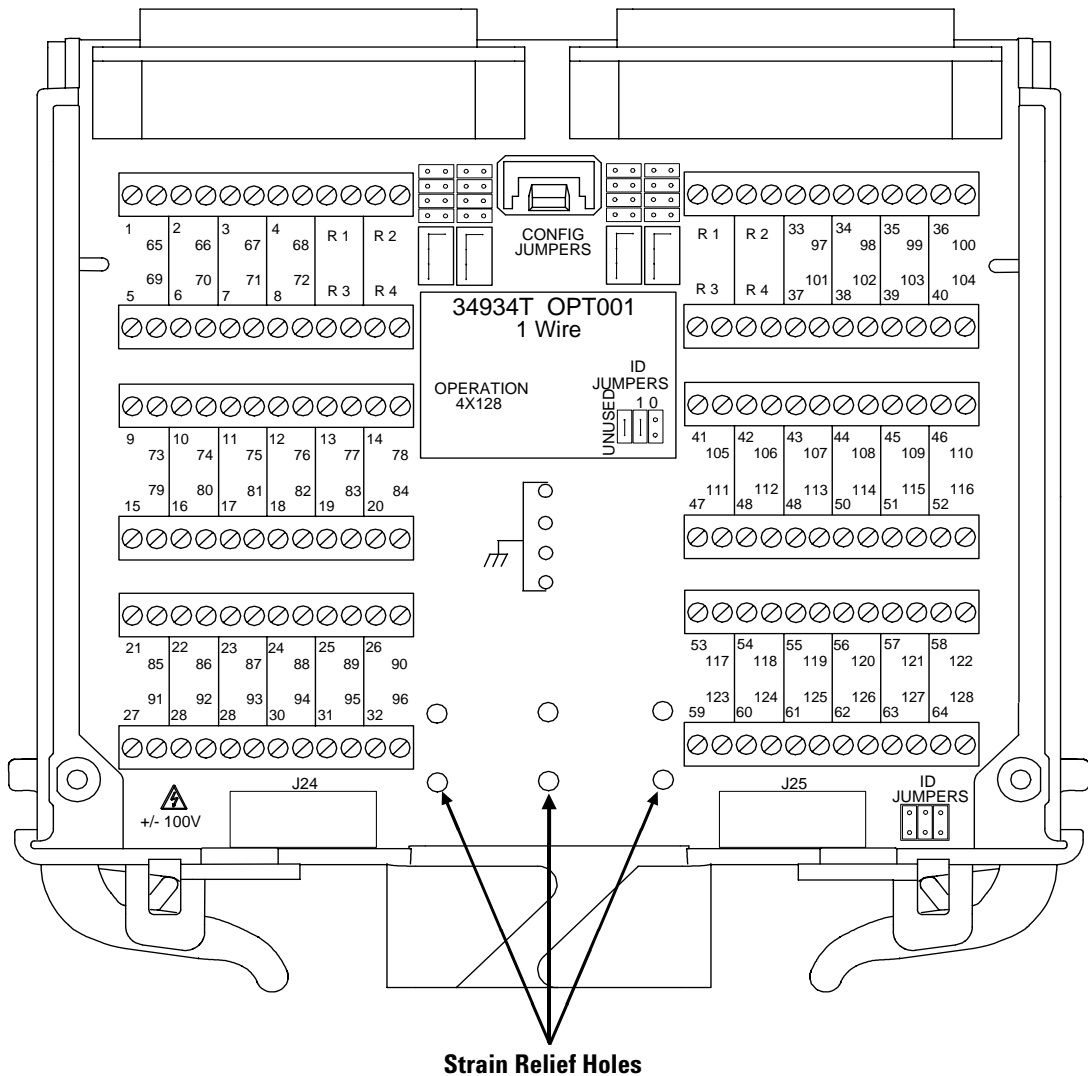

Note the six strain relief holes provided in the terminal block PCB. See the following page for instructions on providing wiring strain relief.

Terminal block strain relief

To reduce strain on the wiring at the terminals and maintain connection reliability, a strain relief feature has been incorporated into the terminal block design. Six holes have been placed near the lower edge of the circuit board, lined up with holes in the terminal block's bottom cover, as seen on “34934T-001 Terminal Block: 4x128 Layout” on page 70.

To use this feature:

- 1 Once all jumpers are installed and wiring is connected to the terminals, arrange the wires leading away from the terminal block in two bundles. This is easiest if the left bundle leads to the terminals on the left side of the block, and conversely for the right side.
- 2 Insert a cable tie (tie-wrap, zip-tie) down through each of the four outside holes in the PCB, continuing down through the holes in the terminal block's bottom cover.
- 3 Route these cable ties up through the center holes in the bottom cover and PCB.
- 4 Close and tighten the cable ties as required, and remove any excess so that it does not interfere with cover closure.

The completed bundles are shown below.

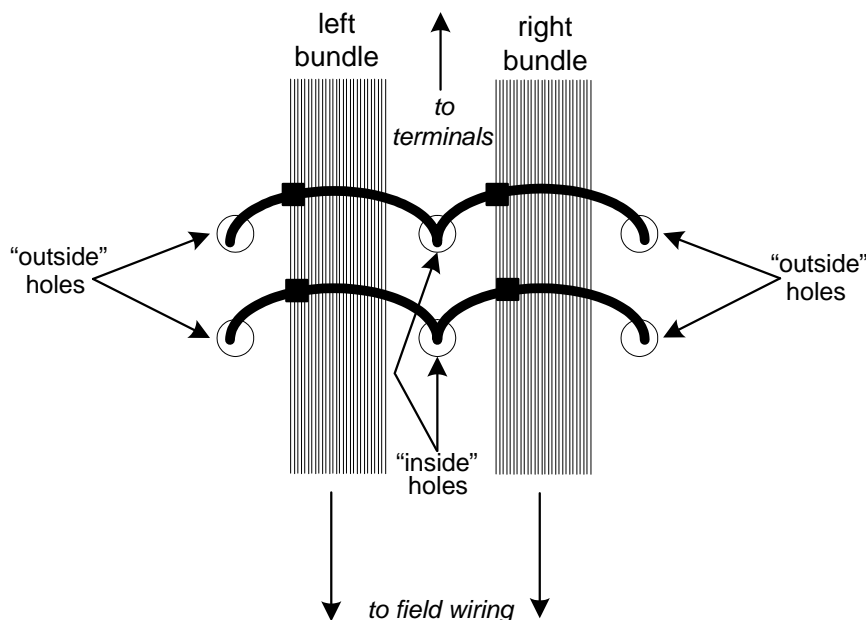

34934T-001 Terminal Block: 4x128 Jumper Configuration

This terminal block has three types of jumpers which must be connected to configure the 4x128 matrix (matrices):

- **CONFIG Jumpers:** place these 2-pin jumpers *identically on all four* 4x2 blocks of jumper pins located near the board's female D-Sub connectors, as shown.
- **ID Jumpers:** place these 2-pin jumpers on a 2x3 block of jumper pins on the lower right corner of the board, as shown.
- **Safety Interlock Continuity Jumpers:** place the supplied pre-wired terminators or equivalent custom wiring on the two 20-pin extension headers at the bottom of the terminal block, as shown.

Placing CONFIG Jumpers for 4x128 The CONFIG jumper area—shown below with jumpers removed—has an illustration below it (on the *4x128 removable overlay*) providing jumper placement guidance for 4x128 matrix configuration.

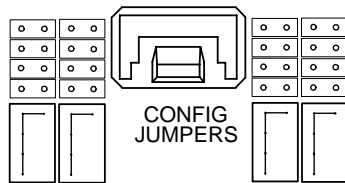

There are four 4x2 blocks of CONFIG JUMPER pins on either side of the board's center—you *must* set all four blocks identically.

- 1 Place eight vertically positioned jumpers as shown below.

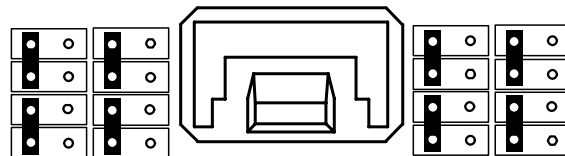

- 2 Then stack four more vertically positioned jumpers as shown below. **Note:** these stack *above* the jumpers you placed in step 1, connecting the second and third rows of pins in each 4x4 block of jumper pins.

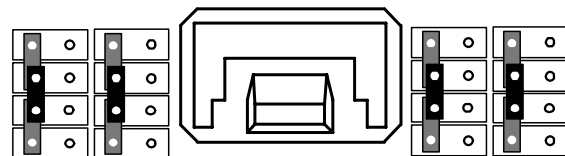

- 3 Then stack four horizontally positioned jumpers as shown below.

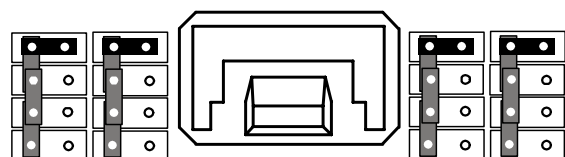

Placing ID Jumpers for 4x128 The ID jumpers allow the 34980A to recognize the 4x128 matrix configuration upon mainframe bootup. Jumper placement guidance is provided on the *4x128 removable overlay* (below left); the ID jumper block is shown at right with jumpers removed.

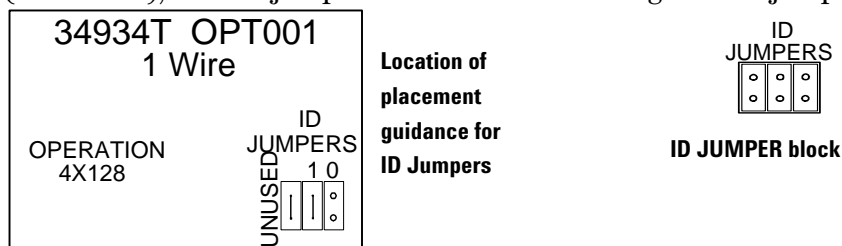

To set the correct ID code for 4x128, place two vertically positioned jumpers as shown below.

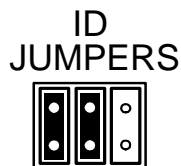

Placing Safety Interlock Continuity Jumpers for 4x128 At the bottom (end opposite the D-Sub connectors) of the terminal block are two 20-pin extension headers—marked J24 and J25 on the circuit board. These headers provide access to the module’s rows. Pins 19 and 20 on each header must be shorted to provide continuity for the module’s safety interlock function.

Two keyed 20-pin terminators are supplied for providing safety interlock continuity. Install the terminators securely in the headers, as shown below.

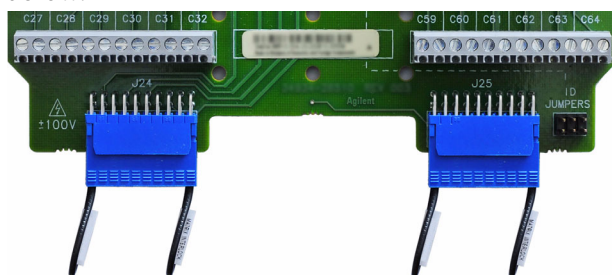

The supplied terminators incorporate both the shorting jumper for pins 19 and 20 and a jumper precluding connection to pins 1 and 2. Detailed pin diagrams for these terminators are provided on [page 76](#).

34934T-001 Terminal Block: 4x128 Wiring

Once the required jumpers have been placed to configure the terminal block as 4x128, you are ready to make row and column connections to the terminal block.

You may connect to the module's rows and columns by wiring to the screw terminals marked C1 through C128 (H, L) and R1 through R4 (H, L) on the *4x128 removable overlay*. The combined weight of these wires can create significant strain on the wiring; to minimize this see [“Terminal block strain relief”](#) on page 71.

However, you may prefer to use physically separate cabling for the row connections (e.g. if you connect your DUT to the columns and your measurement device(s) to the rows). The terminal block's extension headers J24 and J25 provide access to the rows; you can make row connections to the central 16 terminals (pins 3-18) on the supplied terminators you installed in [“Placing Safety Interlock Continuity Jumpers for 4x128”](#) on page 73.

Below is an illustration of the possible locations for making row signal connections to the 34934T-001:

You can connect row signals to the screw terminals here...

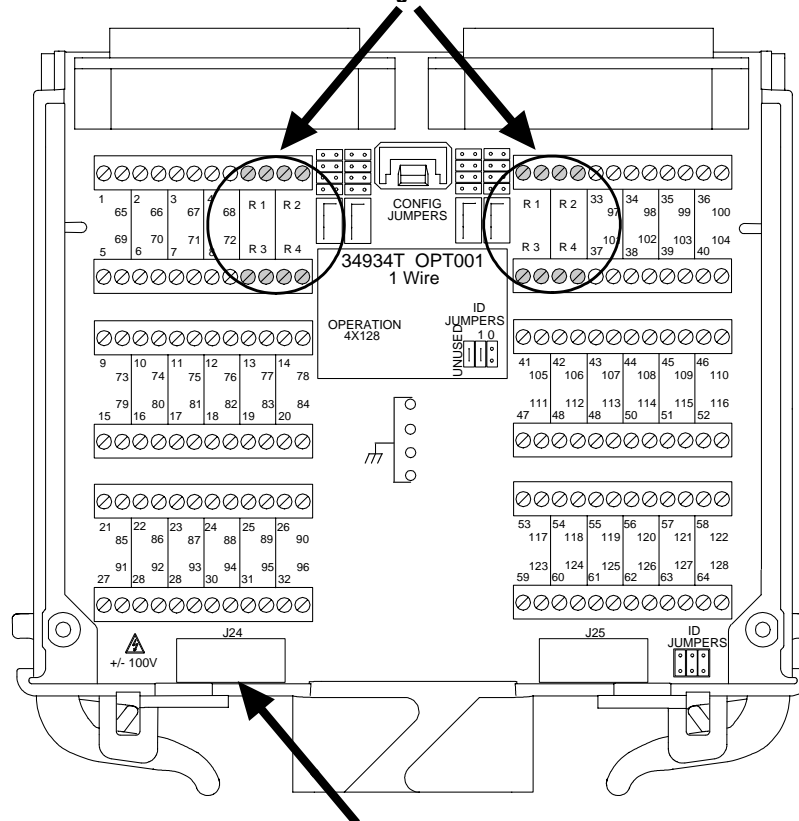

...or to the central 16 pins of extension header J24 here.

The following subsection outlines how to make row connections to extension header J24.

Extension Header (Row Signal) Wiring for 4x128

The position of extension headers J24 and J25 are marked on the 34934T-001's silk-screen. Oriented with the terminal side of the board up, the pin assignments for these headers are shown below.

Extension Headers J24 and J25

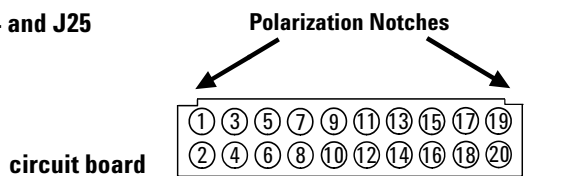

The supplied 20-pin terminators are identical. For 4x128, you can only make row connections to header J24. The terminal numbers—corresponding to the headers—are shown below. *Pay careful attention to the indexing keys on the connectors, to correctly identify terminal #1.*

20-Pin Terminators for J24 and J25

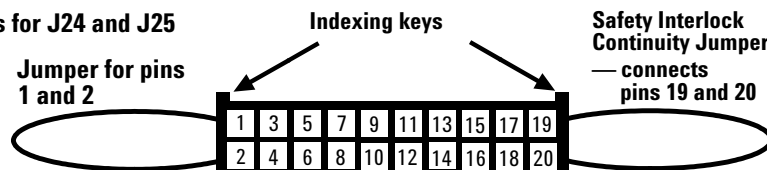

You must fabricate custom cabling to make row signal connections to the central 16 pins (3-18) of header J24, using the pin assignments below. The supplied blue terminators accommodate 22 AWG coated wire, fitted to “crimp-to-wire” contacts with latch tabs (FCI part #76357-301LF or equivalent).

As no row access is provided for J25, keep the supplied safety interlock terminator installed in J25.

Note that each row signal (R1 through R4 (H,L) is routed out on two pins on J24. You can make row signal connections to either row (upper, lower) of the connector.

34934T-001: Extension Header Pin Assignments for 4x128

Header J24				Header J25			
Description	Pin	Description	Pin	Description	Pin	Description	Pin
No connect	1	No connect	2	No connect	1	No connect	2
R1	3	R1	4	No connect	3	No connect	4
No connect	5	No connect	6	No connect	5	No connect	6
R2	7	R2	8	No connect	7	No connect	8
No connect	9	No connect	10	No connect	9	No connect	10
R3	11	R3	12	No connect	11	No connect	12
No connect	13	No connect	14	No connect	13	No connect	14
R4	15	R4	16	No connect	15	No connect	16
No connect	17	No connect	18	No connect	17	No connect	18
IL1	19	IL2	20	IL3	19	IL4	20

Configuring a 4x128 Matrix using a Configuration Block

34934C-001 Configuration Block: Layout

This configuration block is labeled with the model number and the abbreviated module name.

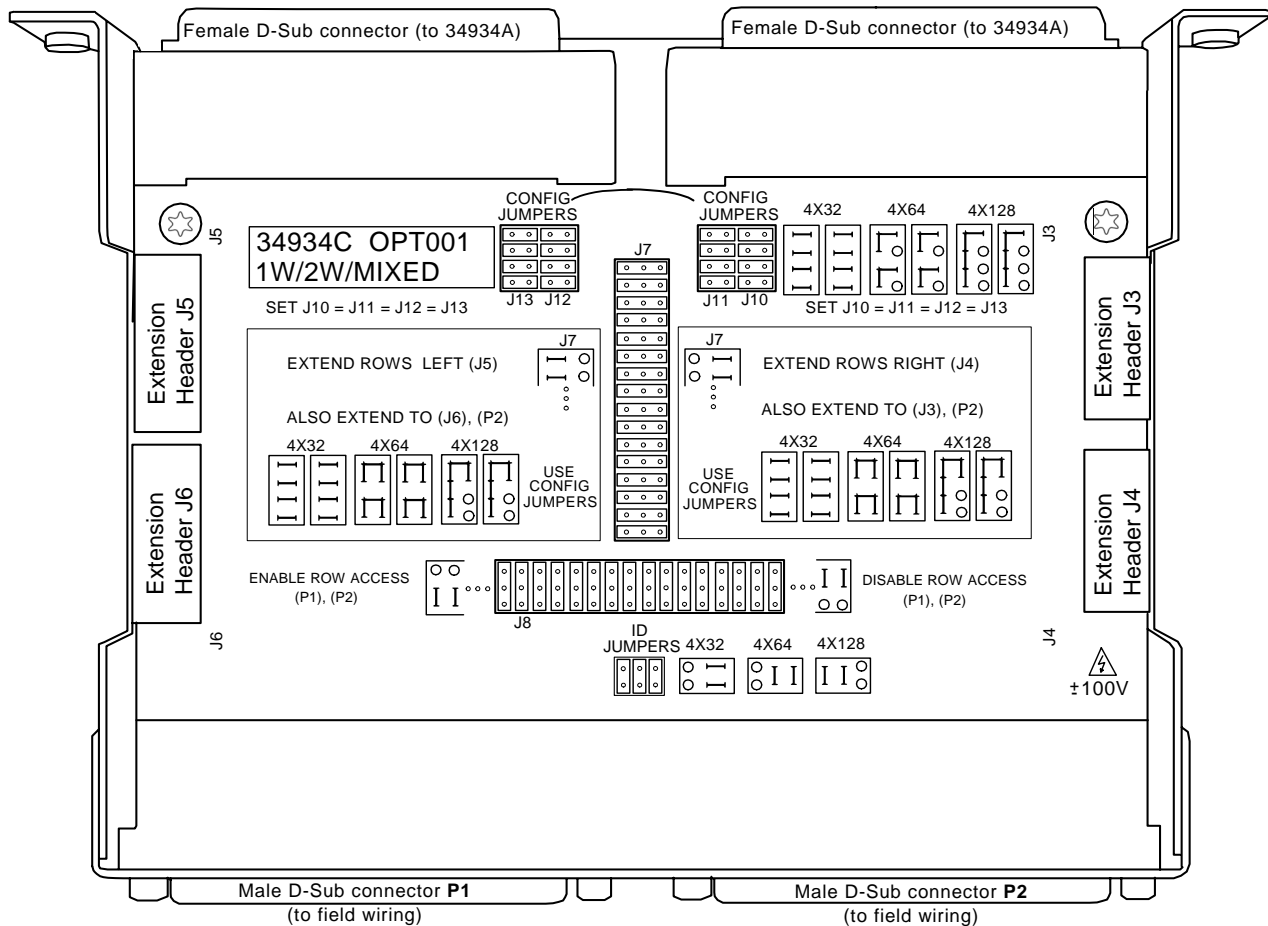

Note four types of on-board jumpers you'll have to set to configure this board; some will be familiar from the configuration descriptions of the *terminal blocks*, but some are new. Instructions for setting these are provided in “[34934C-001 Configuration Block: 4x128 Jumper Configuration](#)” on page 77.

- ID Jumpers
- CONFIG Jumpers (J10, J11, J12 and J13)
- Row Extension Jumpers (J7)
- Row Access Jumpers (J8)

Also note the four extension headers (J3, J4, J5 and J6). Instructions for wiring to these are provided in “[34934C-001 Configuration Block: Wiring](#)” on page 83.

34934C-001 Configuration Block: 4x128 Jumper Configuration

The configuration block has five types of jumpers which must be connected to configure it for use in an expanded 4-row matrix. In this section, you will place:

- **ID Jumpers:** place these 2-pin jumpers on a 2x3 block of jumper pins near the bottom center of the board. See [“Placing ID Jumpers on the 34934C-001 Configuration Block for 4x128”](#) on page 78.
- **CONFIG Jumpers:** place these 2-pin jumpers *identically on all four* 4x2 blocks of jumper pins located near the board’s female D-Sub connectors. See [“Placing CONFIG Jumpers on the 34934C-001 for 4x128”](#) on page 79.
- **Row Extension Jumpers:** place these 16-pin jumpers on a 16x3 block (J7) of jumper pins at the board’s center. See [“Placing Row Extension Jumpers on the 34934C-001 Configuration Block”](#) on page 80.
- **Row Access Jumpers:** place these 16-pin jumpers on a 3x16 block of jumper pins located just above the ID Jumpers. See [“Placing Row Access Jumpers on the 34934C-001 Configuration Block”](#) on page 81.
- **Safety Interlock Continuity Jumpers:** place the supplied pre-wired terminators on the four 20-pin extension headers at the sides of the configuration block. See [“Placing Safety Interlock Continuity Jumpers on the 34934C-001 Configuration Block”](#) on page 82.

Placing ID Jumpers on the 34934C-001 Configuration Block for 4x128 The ID jumpers allow the 34980A to recognize the base matrix configuration used by the 34934C-001, upon mainframe bootup. The ID jumpers are placed in a 2x3 jumper block, located below jumper block J8. Jumper placement guidance is provided on the configuration block's silk-screen, to the right of the jumpers:

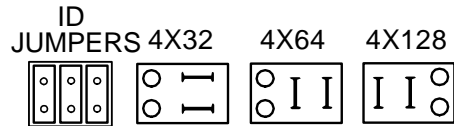

To set the correct ID code for 4x128, place two horizontally positioned jumpers in the right position, as shown below.



Placing CONFIG Jumpers on the 34934C-001 for 4x128 The CONFIG jumper area—shown below with jumpers removed—has an illustration to its right providing jumper placement guidance for the 4x32, 4x64 and 4x128 base matrix configurations.

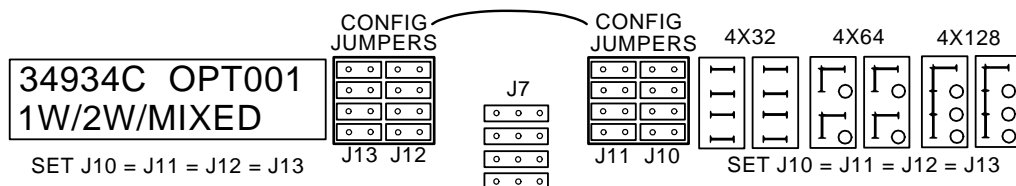

To set the CONFIG jumpers for 4x128:

- 1 Place four horizontally positioned jumpers as shown at right.

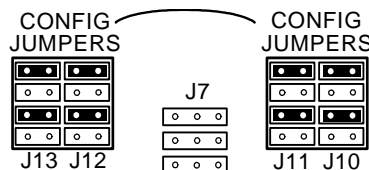

- 2 Then place four vertically positioned jumpers as shown at right.

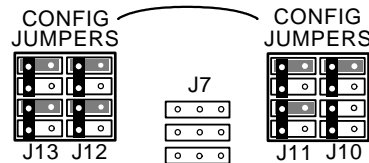

- 3 Then stack eight vertically positioned jumpers above the other jumpers, as shown at right.

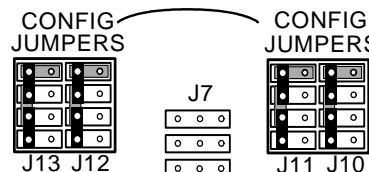

This board configuration (through step 3) “extends” the four row signals either left to connector J5 or right to connector J4, depending on the placement of jumpers in block J7. The row signals will also be extended to male D-Sub connector P1, if “enabled” by placement of jumpers in block J8. *This provides typical row connectivity options.*

- 4 **Optional Step:** For the 4x128 base configuration, *additional* jumpers must be placed to provide these additional options for row connectivity:

- extend the row signals either left to connector J6 or right to connector J3, depending on the placement of jumpers in block J7.
- extend the row signals to male D-Sub connector P2, if “enabled” by placement of jumpers in block J8.

If these additional row connectivity options are desired, stack four additional vertically positioned jumpers as shown at right.

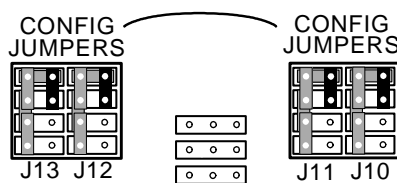

This optional step is implied by the silk-screened guidance provided on the board at either side of jumper block J7.

Placing Row Extension Jumpers on the 34934C-001 Configuration Block The jumpers in 16x3 jumper block J7 (at board center) determine if row connections can be made from the left or right side of the board (i.e. they “extend” the row signal connection points out to *only one* of the two pairs of blue 20-pin connectors at the sides of the configuration block).

Note that “row connections” at minimum include the connections between modules in the matrix, but may also include your access from field wiring to the matrix rows.

Setting these jumpers provides you the flexibility to plan how to route your custom cabling, depending on slot placement of the individual 34934A modules and their corresponding 34934C-001 blocks.

The following illustration shows the jumper block J7, along with the relevant guidance provided on the board’s silk-screen for jumper placement:

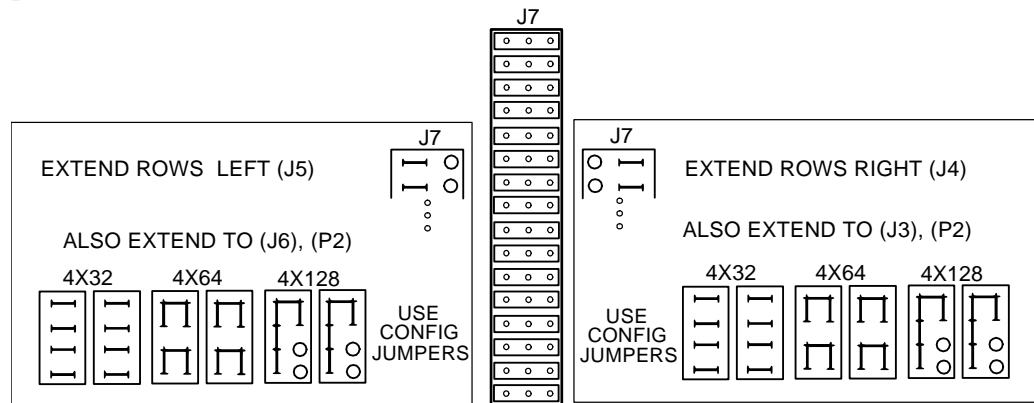

If you plan to extend rows left, to J5 and J6, place two 2x8 jumpers as shown at right.

The row signals will also be present on J6 *if* you placed the optional CONFIG jumpers in step 4 on [page 79](#)

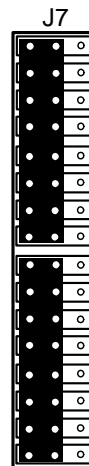

If you plan to extend rows right, to J3 and J4, place two 2x8 jumpers as shown at right.

The row signals will also be present on J3 *if* you placed the optional CONFIG jumpers in step 4 on [page 79](#).

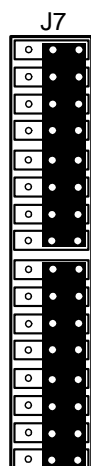

Placing Row Access Jumpers on the 34934C-001 Configuration Block The jumpers in 3x16 jumper block J8 (at lower board center) determine if row connections can be made from the two male D-Sub connectors P1 and P2 (i.e. they “enable” the row signal connection points at the D-subs).

These “row connections” are the traditional access points from field wiring to the matrix rows. In practice, your arrangement of test instrumentation and DUT test points will determine if you wish to make row connections at the D-subs, at the blue 20-pin connectors, or both.

Setting these jumpers provides you the flexibility to plan how to route your custom cabling.

The following illustration shows the jumper block J8, along with the relevant guidance provided on the board’s silk-screen for jumper placement:

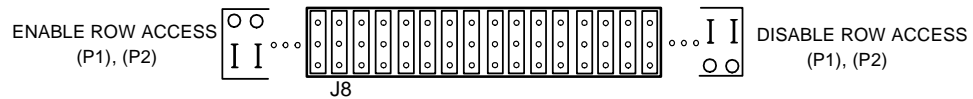

If you plan to connect row signals to the D-sub connectors, place two 2x8 jumpers as shown below.

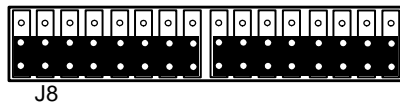

If you do not need to connect row signals to the D-sub connectors, place two 2x8 jumpers as shown below.

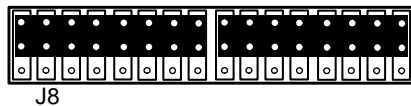

By not routing signals to the D-sub connectors, you avoid adding their extra capacitance.

Placing Safety Interlock Continuity Jumpers on the 34934C-001 Configuration Block

Block At each side of the configuration block are a pair of 20-pin extension headers. On the right side are labeled J3 and J4; on the left side are J5 and J6. In all cases, pins 19 and 20 are the safety interlock pins.

These headers provide for row extension and row signal access, depending on the placement of the jumpers in J7. You must have set the jumpers to extend rows either to the left or right side (of the configuration block) (see “[Placing Row Extension Jumpers on the 34934C-001 Configuration Block](#)” on page 80).

To provide continuity for the module’s safety interlock function, pins 19 and 20 on *both* extension headers on the selected side (left or right) must be shorted.

- For each of these headers, install one of the supplied keyed 20-pin terminators securely in that header, as shown below.

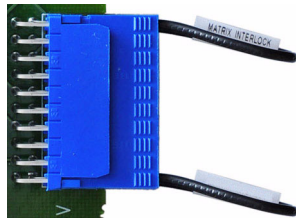

The supplied terminators incorporate both the shorting jumper for pins 19 and 20 and a jumper precluding connection to pins 1 and 2.

- The extension headers on the opposite side of the 34934C-001 do not require a safety interlock terminator; these will be hidden by the configuration block’s cover.

34934C-001 Configuration Block: Wiring

The next two subsections outline options for making row and column wiring connections to the configuration block.

Extension Header (Row Signal) Wiring to the 34934C-001

Below is an illustration of the possible locations for making row signal connections to the 34934T-001

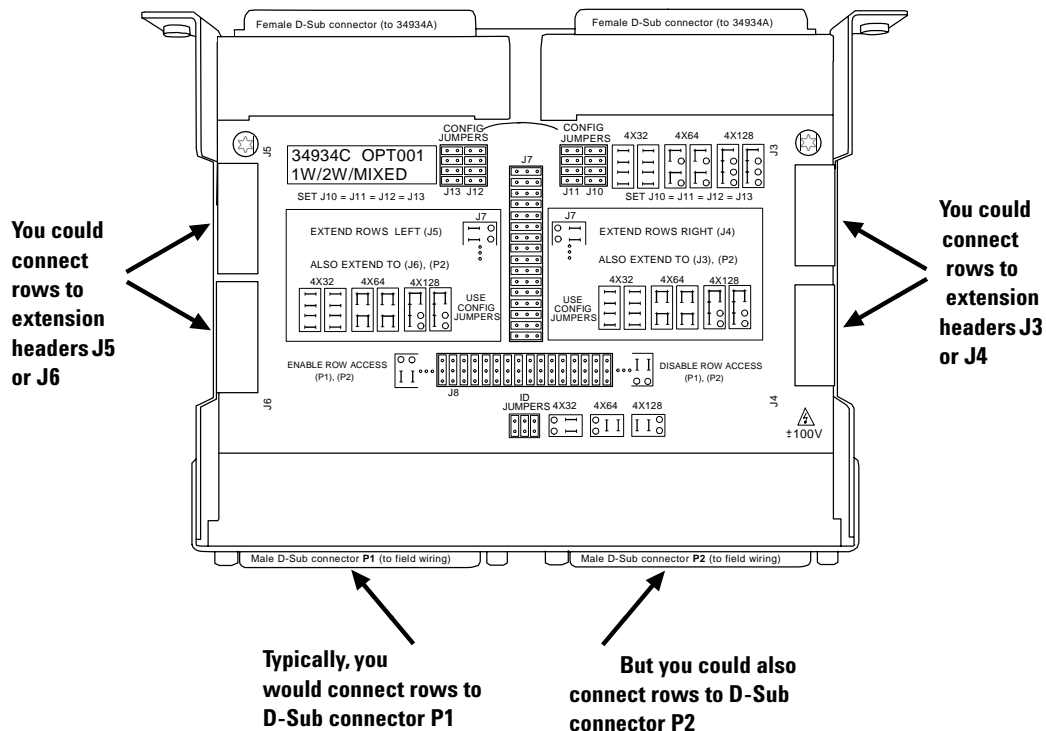

Typically, you could make both row and column connections to each module by fabricating custom cabling terminating in female D-Sub connectors. These attach to the configuration block's male D-Sub connectors P1 and P2.

Alternately, you may choose to connect only columns (typically test points on your DUT) to the D-Subs. There may be physical or electrical advantages in making your *row* connections (typically measurement devices) to the configuration block's blue extension connectors J3, J4, J5 and J6. To provide this flexibility, two extension headers are provided on each side of the configuration block.

You must have set the jumpers (in "Placing Row Extension Jumpers on the 34934C-001 Configuration Block" on page 80) to extend rows to two of the four headers. We'll call these the "live" headers.

Had you created *two* live headers, by performing step 4 on page 79; then the second header (J3 or J6) on the side selected by jumpers J7 will also be a live header.

In “Placing Safety Interlock Continuity Jumpers on the 34934C-001 Configuration Block” on page 82, you will have installed the supplied blue terminators in the live headers on the configuration block.

You can now make row connections to these headers, by utilizing the central 16 pins (3-18) on the snap-in terminators. The extension header’s supplied terminator is shown below. Pay careful attention to the polarizing notches for identification of pin 1:

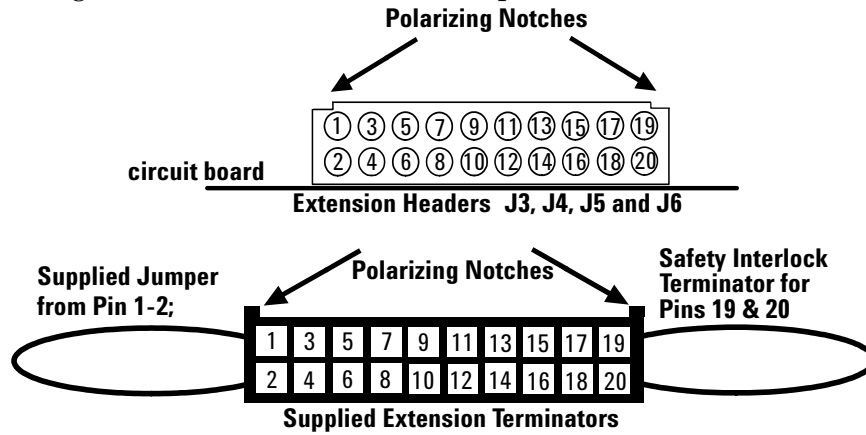

34934C-001: Extension Header Pin Assignments for 4x128

Headers J4, J5				Headers J3, J6			
Description	Pin	Description	Pin	Description	Pin	Description	Pin
No connect	1	No connect	2	No connect	1	No connect	2
R1	3	R1	4	R1	3	R1	4
No connect	5	No connect	6	No connect	5	No connect	6
R2	7	R2	8	R2	7	R2	8
No connect	9	No connect	10	No connect	9	No connect	10
R3	11	R3	12	R3	11	R3	12
No connect	13	No connect	14	No connect	13	No connect	14
R4	15	R4	16	R4	15	R4	16
No connect	17	No connect	18	No connect	17	No connect	18
IL1	19	IL2	20	IL3	19	IL4	20

If you are going to create an expanded-row matrix using multiple modules and configuration blocks, plan your wiring placement for each configuration block carefully, to allow for a daisy-chain interconnection between configuration blocks—in addition to any row wiring you may connect to the expansion headers. This interconnection is illustrated in “Arranging Multiple 34934A Modules with Configuration Blocks” on page 160.

34934C-001 D-Sub Connectors: Pin Assignments for 4x128 (base configuration)

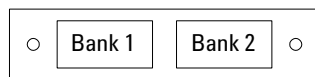

For orientation, the male D-sub connector end of the configuration block is facing you.

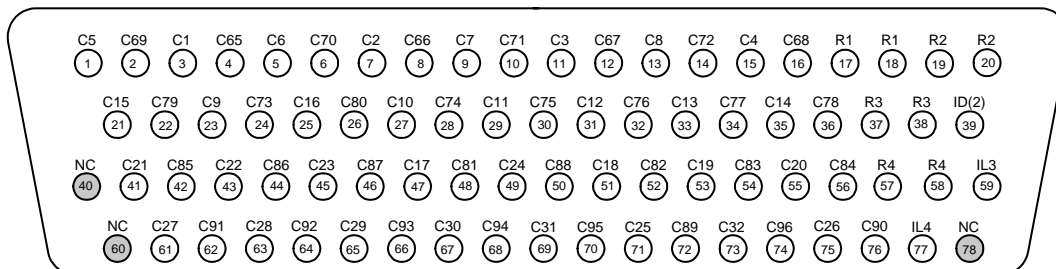

78-Pin D-Sub Male Connector
Bank 1 (P1)

Description	Pin	Description	Pin	Description	Pin	Description	Pin	Description	Pin	Description	Pin
R1	17	C1	3	C17	47	C65	4	C81	48	ID2	39
R1	18	C2	7	C18	51	C66	8	C82	52	IL3	59
R2	19	C3	11	C19	53	C67	12	C83	54	IL4	77
R2	20	C4	15	C20	55	C68	16	C84	56	No connect	40
R3	37	C5	1	C21	41	C69	2	C85	42	No connect	60
R3	38	C6	5	C22	43	C70	6	C86	44	No connect	78
R4	57	C7	9	C23	45	C71	10	C87	46		
R4	58	C8	13	C24	49	C72	14	C88	50		
		C9	23	C25	71	C73	24	C89	72		
		C10	27	C26	75	C74	28	C90	76		
		C11	29	C27	61	C75	30	C91	62		
		C12	31	C28	63	C76	32	C92	64		
		C13	33	C29	65	C77	34	C93	66		
		C14	35	C30	67	C78	36	C94	68		
		C15	21	C31	69	C79	22	C95	70		
		C16	25	C32	73	C80	26	C96	74		

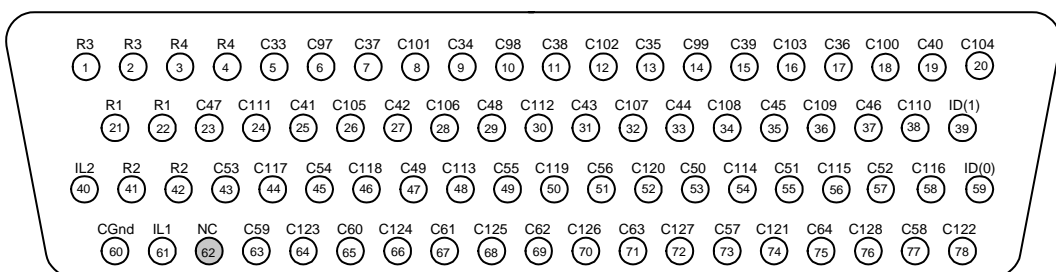

78-Pin D-Sub Male Connector
Bank 2 (P2)

Description	Pin	Description	Pin	Description	Pin	Description	Pin	Description	Pin	Description	Pin
R1	21	C33	5	C49	47	C97	6	C113	48	ID1	39
R1	22	C34	9	C50	53	C98	10	C114	54	ID0	59
R2	41	C35	13	C51	55	C99	14	C115	56	IL1	61
R2	42	C36	17	C52	57	C100	18	C116	58	IL2	40
R3	1	C37	7	C53	43	C101	8	C117	44	Com Gnd	60
R3	2	C38	11	C54	45	C102	12	C118	46	No connect	62
R4	3	C39	15	C55	49	C103	16	C119	50		
R4	4	C40	19	C56	51	C104	20	C120	52		
		C41	25	C57	73	C105	26	C121	74		
		C42	27	C58	77	C106	28	C122	78		
		C43	31	C59	63	C107	32	C123	64		
		C44	33	C60	65	C108	34	C124	66		
		C45	35	C61	67	C109	36	C125	68		
		C46	37	C62	69	C110	38	C126	70		
		C47	23	C63	71	C111	24	C127	72		
		C48	29	C64	75	C112	30	C128	76		

34934C-001 D-Sub Connectors: Safety Interlock Continuity Wiring for 4x128

While wiring to the 34934C-001's D-Sub connectors, you *must* make the following connections—in addition to the 4x128 row and column connections—to provide for safety interlock continuity:

Short: Pin 59 to Pin 77 on Bank 1

Short: Pin 40 to Pin 61 on Bank 2

Configuring a 4x128 Matrix by Direct Wiring

34934A D-Sub Connectors: 4x128 Pin Assignments

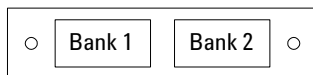

For orientation, the D-sub connector end of the module is facing you.

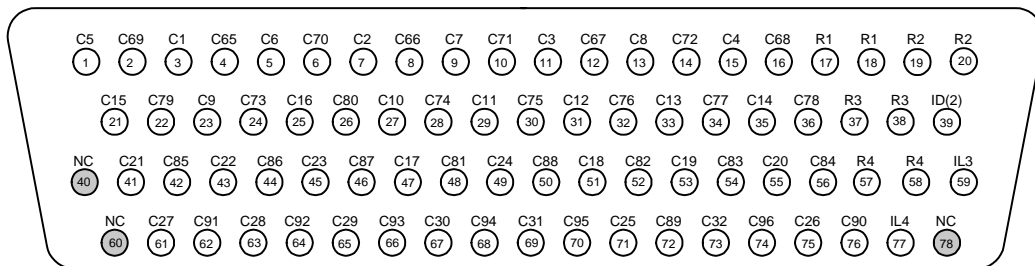

78-Pin D-Sub Male Connector

Bank 1

Description	Pin	Description	Pin	Description	Pin	Description	Pin	Description	Pin	Description	Pin
R1	17	C1	3	C17	47	C65	4	C81	48	ID2	39
R1	18	C2	7	C18	51	C66	8	C82	52	IL3	59
R2	19	C3	11	C19	53	C67	12	C83	54	IL4	77
R2	20	C4	15	C20	55	C68	16	C84	56	No connect	40
R3	37	C5	1	C21	41	C69	2	C85	42	No connect	60
R3	38	C6	5	C22	43	C70	6	C86	44	No connect	78
R4	57	C7	9	C23	45	C71	10	C87	46		
R4	58	C8	13	C24	49	C72	14	C88	50		
		C9	23	C25	71	C73	24	C89	72		
		C10	27	C26	75	C74	28	C90	76		
		C11	29	C27	61	C75	30	C91	62		
		C12	31	C28	63	C76	32	C92	64		
		C13	33	C29	65	C77	34	C93	66		
		C14	35	C30	67	C78	36	C94	68		
		C15	21	C31	69	C79	22	C95	70		
		C16	25	C32	73	C80	26	C96	74		

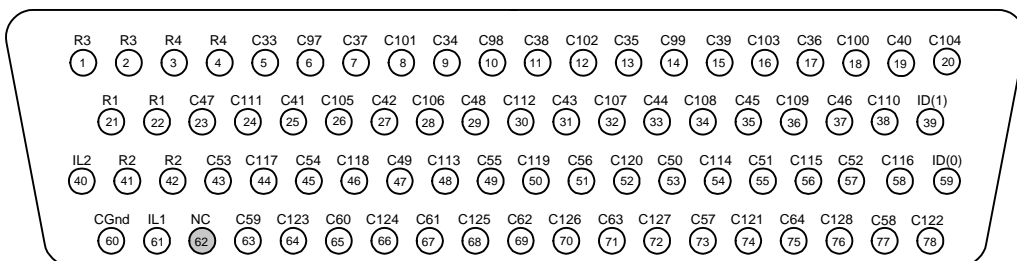

78-Pin D-Sub Male Connector

Bank 2

Description	Pin	Description	Pin	Description	Pin	Description	Pin	Description	Pin	Description	Pin
R1	21	C33	5	C49	47	C97	6	C113	48	ID1	39
R1	22	C34	9	C50	53	C98	10	C114	54	ID0	59
R2	41	C35	13	C51	55	C99	14	C115	56	IL1	61
R2	42	C36	17	C52	57	C100	18	C116	58	IL2	40
R3	1	C37	7	C53	43	C101	8	C117	44	Com Gnd	60
R3	2	C38	11	C54	45	C102	12	C118	46	No connect	62
R4	3	C39	15	C55	49	C103	16	C119	50		
R4	4	C40	19	C56	51	C104	20	C120	52		
		C41	25	C57	73	C105	26	C121	74		
		C42	27	C58	77	C106	28	C122	78		
		C43	31	C59	63	C107	32	C123	64		
		C44	33	C60	65	C108	34	C124	66		
		C45	35	C61	67	C109	36	C125	68		
		C46	37	C62	69	C110	38	C126	70		
		C47	23	C63	71	C111	24	C127	72		
		C48	29	C64	75	C112	30	C128	76		

34934A Module D-Sub Connectors: 4x128 Wiring

When wiring directly to the 34934A's D-Sub connectors, you *must* make the following connections—in addition to row and column connections—to configure the 4x128 matrix (matrices):

Module Configuration: The connections listed below short the pairs of rows in the 34934A's native 4x4x32 configuration to create the 4x128 matrix.

Short: Pin 17 on Bank 1 to Pin 21 on Bank 2
 Short: Pin 18 on Bank 1 to Pin 22 on Bank 2
 Short: Pin 19 on Bank 1 to Pin 41 on Bank 2
 Short: Pin 20 on Bank 1 to Pin 42 on Bank 2
 Short: Pin 37 on Bank 1 to Pin 1 on Bank 2
 Short: Pin 38 on Bank 1 to Pin 2 on Bank 2
 Short: Pin 57 on Bank 1 to Pin 3 on Bank 2
 Short: Pin 58 on Bank 1 to Pin 4 on Bank 2
 Short: Pin 17 to Pin 18 on Bank 1
 Short: Pin 19 to Pin 20 on Bank 1
 Short: Pin 37 to Pin 38 on Bank 1
 Short: Pin 57 to Pin 58 on Bank 1

Note that eight of these connections require wires run *between* the two D-Sub connectors. You may make these connections near your test instrumentation or DUT, or near the D-Sub ends of your custom cabling.

Module ID: The connections listed below allow the 34980A mainframe to recognize the 4x128 matrix configuration.

Leave Open: Pin 39 on Bank 1 (ID bit 2)
 Ground: Pin 39 on Bank 2 (ID bit 1)
 Leave Open: Pin 59 on Bank 2 (ID bit 0)

Safety Interlock Continuity: The connections listed below provide for safety interlock continuity.

Short: Pin 59 to Pin 77 on Bank 1
 Short: Pin 40 to Pin 61 on Bank 2

NOTE

If you use the 34934C-001 Configuration Block—in conjunction with the 34934A module—to make wiring connections, the additional **Module Configuration** and **Module ID** connections are *not required*. Those connections are made within the hardware of the configuration block. You would need only make the **Safety Interlock Continuity** connections.

8x32 Matrix Configuration

To create an 8x32 matrix, you may connect your field wiring to the 34934A by three methods:

Terminal Block You can use terminal block 34934T-002. The terminal block connects to the 34934A's two D-Sub connectors; it provides 12 blocks of 12 screw terminals each, and silk-screened guidance for field wiring the 8x32 matrices. Follow these sections in order to configure and wire the terminal block:

- [“34934T-002 Terminal Block: 8x32 Layout”](#) on page 90
- [“34934T-002 Terminal Block: 8x32 Jumper Configuration”](#) on page 92
- [“34934T-002 Terminal Block: 8x32 Wiring”](#) on page 95

Configuration Block You can use configuration block 34934C-001. Follow these sections in order to configure and wire the configuration block:

- [“34934C-002 Configuration Block: Layout”](#) on page 97
- [“34934C-002 Configuration Block: 8x32 Jumper Configuration”](#) on page 98
- [“34934C-002 Configuration Block: Wiring”](#) on page 104

NOTE

Use of the 34934C-002 precludes use of a piggy-backed 34934T-002 terminal block for field wiring connections; the combination is not mechanically reliable.

Direct Wiring You can wire directly to the module's D-Sub connectors using custom cabling. You will have to short specific pins on and between the D-Sub connectors to create the 8x32 configuration. Review *both* these sections *before* wiring to the module's D-Subs:

- [“34934A module D-Sub Connectors: 8x32 Pin Assignments”](#) on page 108
- [“34934A Module D-Sub Connectors: 8x32 Wiring”](#) on page 109

Configuring an 8x32 Matrix using a Terminal Block

34934T-002 Terminal Block: 8x32 Layout

This terminal block with screw-type connections is labeled with the model number and the abbreviated module name. In addition, space is available on the label for you to write the slot number.

The *34980A Product Reference* CD (shipped with the module) contains a 34934T Wiring Log for you to document your wiring configuration for this module. You can open the wiring log file in Microsoft® Excel® or Adobe® Acrobat® format.

This terminal block's silk-screen shows the row and column terminals for the 8x32 matrix configuration:

Wire Size:
20 AWG (Typical)

18 AWG (Screw
Terminal Max)

24AWG (Max if
all 144 lines are used)

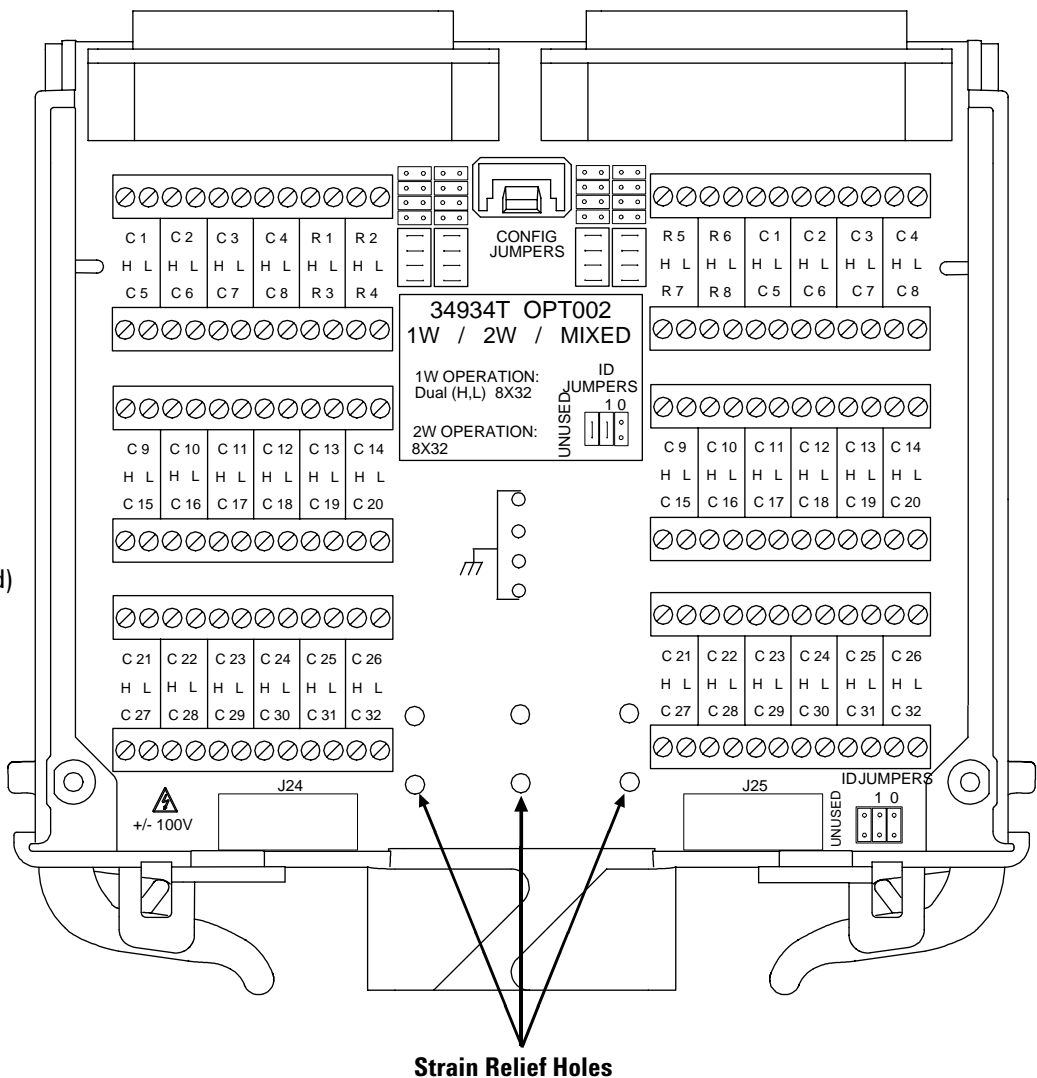

Note the six strain relief holes provided in the terminal block PCB. See the following page for instructions on providing wiring strain relief.

34934T-002 Terminal Block: 8x32 Terminal Wiring Options

On the 34934T-002 terminal block, there are redundant sets of terminals provided for columns 1-32, one set on each side of the block. The column terminals on each side are shorted by traces in the block to their like-labeled counterparts on the other; you may make any column connection to the appropriate terminal on either side.

Terminal block strain relief

To reduce strain on the wiring at the terminals and maintain connection reliability, a strain relief feature has been incorporated into the terminal block design. Six holes have been placed near the lower edge of the circuit board, lined up with holes in the terminal block's bottom cover, as seen on [“34934T-002 Terminal Block: 8x32 Layout”](#) on page 90.

To use this feature:

- 1 Once all jumpers are installed and wiring is connected to the terminals, arrange the wires leading away from the terminal block in two bundles. This is easiest if the left bundle leads to the terminals on the left side of the block, and conversely for the right side.
- 2 Insert a cable tie (tie-wrap, zip-tie) down through each of the four outside holes in the PCB, continuing down through the holes in the terminal block's bottom cover.
- 3 Route these cable ties up through the center holes in the bottom cover and PCB.
- 4 Close and tighten the cable ties as required, and remove any excess so that it does not interfere with cover closure.

The completed bundles are shown below.

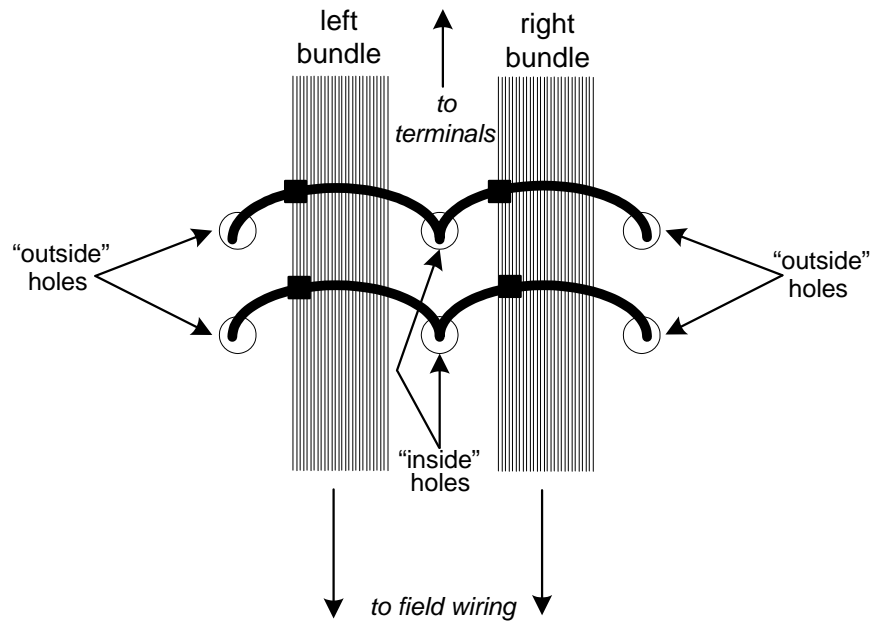

34934T-002 Terminal Block: 8x32 Jumper Configuration

This terminal block has three types of jumpers which must be connected to configure the 8x32 matrix (matrices):

- **CONFIG Jumpers:** place these 2-pin jumpers *identically on all four* 4x2 blocks of jumper pins located near the board's female D-Sub connectors, as shown.
- **ID Jumpers:** place these 2-pin jumpers on a 2x3 block of jumper pins on the lower right corner of the board, as shown.
- **Safety Interlock Continuity Jumpers:** place the supplied pre-wired terminators or equivalent custom wiring on the two 20-pin extension headers at the bottom of the terminal block, as shown.

Placing CONFIG Jumpers for 8x32 The CONFIG jumper area—shown below with jumpers removed—has an illustration below it (on the silk-screen) providing jumper placement guidance for 8x32 matrix configuration.

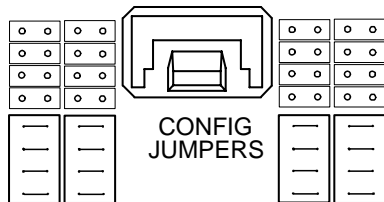

There are four 4x2 blocks of CONFIG JUMPER pins on either side of the board's center—you *must* set all four blocks identically.

- 1 Place sixteen horizontally positioned jumpers as shown below.

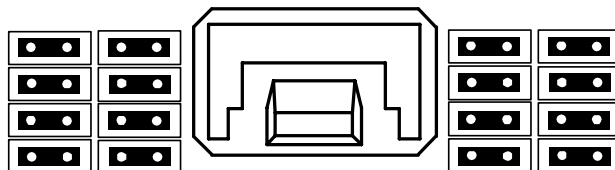

Placing ID Jumpers for 8x32 The ID jumpers allow the 34980A to recognize the 8x32 matrix configuration upon mainframe bootup. Jumper placement guidance is provided on the silk-screen (below left); the ID jumper block is shown at right with jumpers removed.

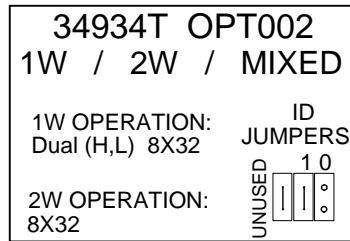

Location of placement guidance for ID Jumpers

ID JUMPERS



ID JUMPER block

To set the correct ID code for 8x32, place two vertically positioned jumpers as shown below.



Placing Safety Interlock Continuity Jumpers for 8x32 At the bottom (end opposite the D-Sub connectors) of the terminal block are two 20-pin extension headers—marked J24 and J25 on the circuit board. These headers provide access to the module’s rows. Pins 19 and 20 on each header must be shorted to provide continuity for the module’s safety interlock function.

Two keyed 20-pin terminators are supplied for providing safety interlock continuity. Install the terminators securely in the headers, as shown below.

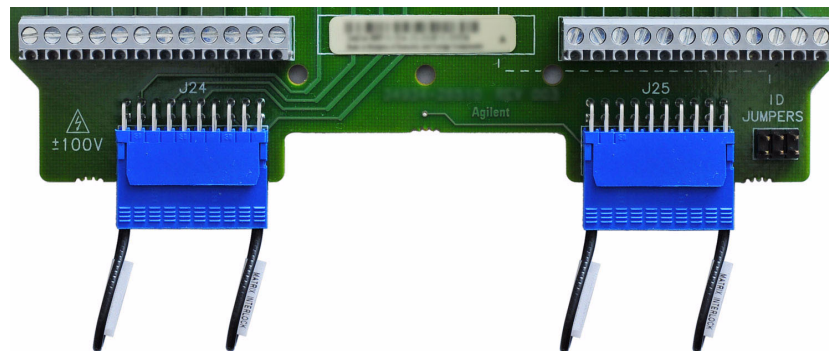

The supplied terminators incorporate both the shorting jumper for pins 19 and 20 and a jumper precluding connection to pins 1 and 2. Detailed pin diagrams for these terminators are provided on [page 96](#).

34934T-002 Terminal Block: 8x32 Wiring

Once the required jumpers have been placed to configure the terminal block as 8x32, you are ready to make row and column connections to the terminal block.

You may connect to the module's rows and columns by wiring to the screw terminals marked C1 through C32 (H, L) and R1 through R8 (H, L) on the silk-screen (see "34934T-002 Terminal Block: 8x32 Layout" on page 90). The combined weight of these wires can create significant strain on the wiring; to minimize this see "Terminal block strain relief" on page 91.

However, you may prefer to use physically separate cabling for the row connections (e.g. if you connect your DUT to the columns and your measurement device(s) to the rows). The terminal block's extension headers J24 and J25 provide access to the rows; you can make row connections to the central 16 terminals (pins 3-18) on the supplied terminators you installed in "Placing Safety Interlock Continuity Jumpers for 8x32" on page 94.

Below is an illustration of the possible locations for making row signal connections to the 34934T-002:

You can connect row signals to the screw terminals here...

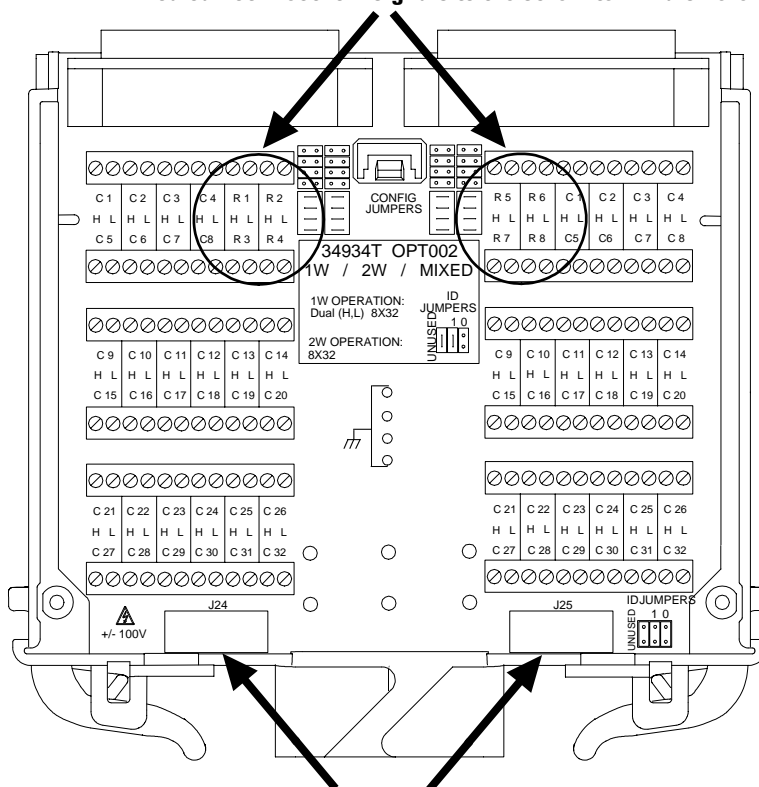

...or to the central 16 pins of extension headers J24 and J25 here.

The following subsection outlines how to make row connections to extension headers J24 and J25.

Extension Header (Row Signal) Wiring for 8x32 The position of extension headers J24 and J25 are marked on the 34934T-002’s silk-screen. Oriented with the terminal side of the board up, the pin numbers for these headers are shown below.

Extension Headers J24 and J25

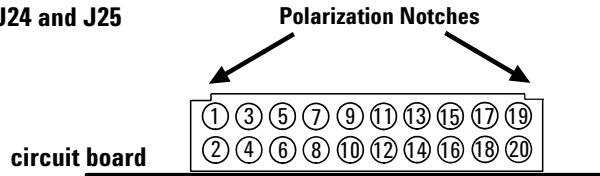

The supplied 20-pin terminators are identical, but the pin assignments for 8x32 are not (rows 1-4 are on J24; rows 5-8 are on J25). The terminal numbers—corresponding to the headers—are shown below. *Pay careful attention to the indexing keys on the connectors, to correctly identify terminal #1.*

20-Pin Terminators for J24 and J25

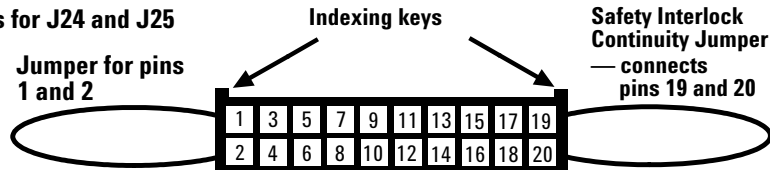

You must fabricate custom cabling to make row signal connections to the central 16 pins (3-18) of these headers, using the pin assignments below. The supplied blue terminators accommodate 22 AWG coated wire, fitted to “crimp-to-wire” contacts with latch tabs (FCI part #76357-301LF or equivalent).

34934T-002: Extension Header Pin Assignments for 8x32

Header J24				Header J25			
Description	Pin	Description	Pin	Description	Pin	Description	Pin
No Connect	1	No Connect	2	No Connect	1	No Connect	2
R1H	3	R1H	4	R5H	3	R5H	4
R1L	5	R1L	6	R5L	5	R5L	6
R2H	7	R2H	8	R6H	7	R6H	8
R2L	9	R2L	10	R6L	9	R6L	10
R3H	11	R3H	12	R7H	11	R7H	12
R3L	13	R3L	14	R7L	13	R7L	14
R4H	15	R4H	16	R8H	15	R8H	16
R4L	17	R4L	18	R8L	17	R8L	18
IL1	19	IL2	20	IL3	19	IL4	20

Note that each row signal (R1 through R8 (H,L)) is routed out on two pins on the extension headers. You can make row signal connections to either row (upper, lower) of the connector.

If you are going to create an expanded-row matrix using multiple modules and terminal blocks, plan your wiring placement for each terminal block carefully, to allow for a daisy-chain interconnection between terminal blocks—in addition to any row wiring you may connect to the expansion headers. This interconnection is illustrated in “[Arranging Multiple 34934A Modules with Terminal Blocks](#)” on page 158.

Configuring an 8x32 Matrix using a Configuration Block

34934C-002 Configuration Block: Layout

This configuration block is labeled with the model number and the abbreviated module name.

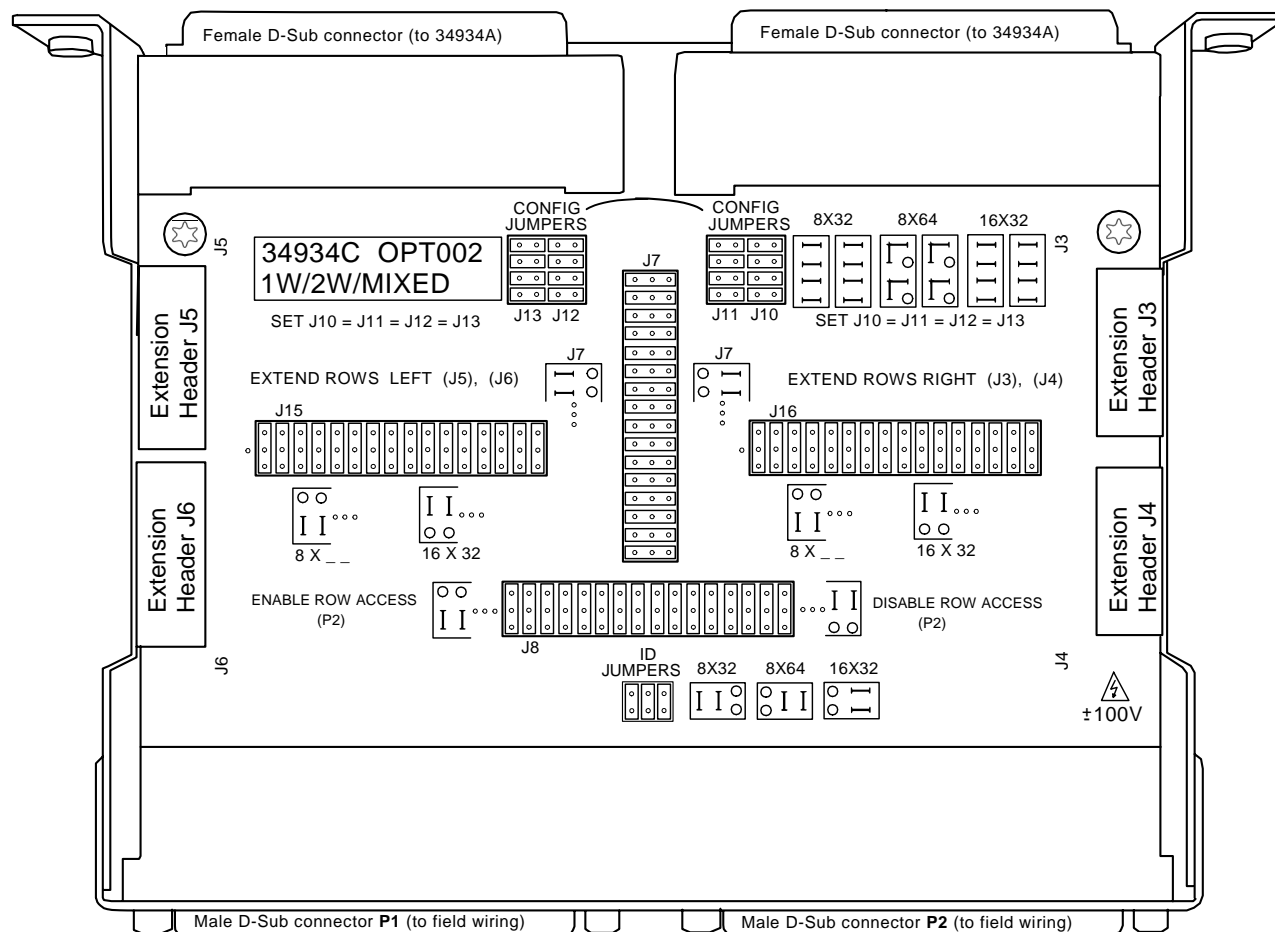

Note five types of on-board jumpers you'll have to set to configure this board; some will be familiar from the configuration descriptions of the *terminal blocks*, but some are new. Instructions for setting these are provided in “[34934C-002 Configuration Block: 8x32 Jumper Configuration](#)” on page 98.

- ID Jumpers
- CONFIG Jumpers (J10, J11, J12 and J13)
- Row Extension Jumpers (J7)
- Row Access Jumpers (J8)
- Row Setting Jumpers (J15 and J16)

Also note the four extension headers (J3, J4, J5 and J6). Instructions for wiring to these are provided in “[34934C-002 Configuration Block: Wiring](#)” on page 104.

34934C-002 Configuration Block: 8x32 Jumper Configuration

The configuration block has five types of jumpers which must be connected to configure it for use in an expanded 4-row matrix. In this section, you will place:

- **ID Jumpers:** place these 2-pin jumpers on a 2x3 block of jumper pins near the bottom center of the board. See [“Placing ID Jumpers on the 34934C-002 Configuration Block for 8x32”](#) on page 99.
- **CONFIG Jumpers:** place these 2-pin jumpers *identically on all four* 4x2 blocks of jumper pins located near the board’s female D-Sub connectors. See [“Placing CONFIG Jumpers on the 34934C-002 Configuration Block for 8x32”](#) on page 99.
- **Row Extension Jumpers:** place these 16-pin jumpers on a 16x3 block (J7) of jumper pins at the board’s center. See [“Placing Row Extension Jumpers on the 34934C-002 Configuration Block”](#) on page 100.
- **Row Access Jumpers:** place these 16-pin jumpers on a 3x16 block of jumper pins located just above the ID Jumpers. See [“Placing Row Access Jumpers on the 34934C-002 Configuration Block”](#) on page 101.
- **Safety Interlock Continuity Jumpers:** place the supplied pre-wired terminators on the four 20-pin extension headers at the sides of the configuration block. See [“Placing Safety Interlock Continuity Jumpers on the 34934C-002 Configuration Block”](#) on page 103.

Placing ID Jumpers on the 34934C-002 Configuration Block for 8x32 The ID jumpers allow the 34980A to recognize the base matrix configuration used by the 34934C-002, upon mainframe bootup. The ID jumpers are placed in a 2x3 jumper block, located below jumper block J8. Jumper placement guidance is provided on the configuration block’s silk-screen, to the right of the jumpers:

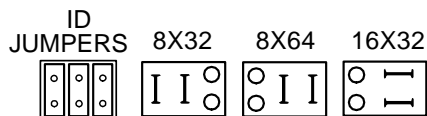

To set the correct ID code for 8x32, place two vertically positioned jumpers in the left position, as shown below.



Placing CONFIG Jumpers on the 34934C-002 Configuration Block for 8x32 The CONFIG jumper area—shown below with jumpers removed—has an illustration to its right providing jumper placement guidance for the 8x32, 8x64 and 16x32 base matrix configurations.

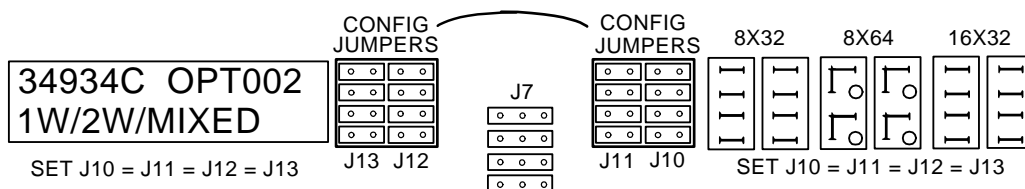

To set the CONFIG jumpers for 8x32, place 16 horizontally positioned jumpers as shown below.

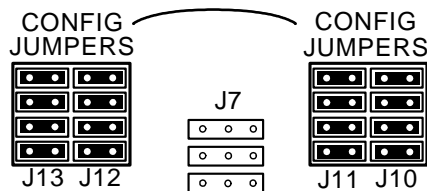

Placing Row Extension Jumpers on the 34934C-002 Configuration Block The jumpers in 16x3 jumper block J7 (at board center) determine if row connections can be made from the left or right side of the board (i.e. they “extend” the row signal connection points out to *only one* of the two pairs of blue 20-pin connectors at the sides of the configuration block).

Note that “row connections” at minimum include the connections between modules in the matrix, but may also include your access from field wiring to the matrix rows.

Setting these jumpers provides you the flexibility to plan how to route your custom cabling, depending on slot placement of the individual 34934A modules and their corresponding 34934C-002 blocks.

The following illustration shows the jumper block J7, along with the relevant guidance provided on the board’s silk-screen for jumper placement:

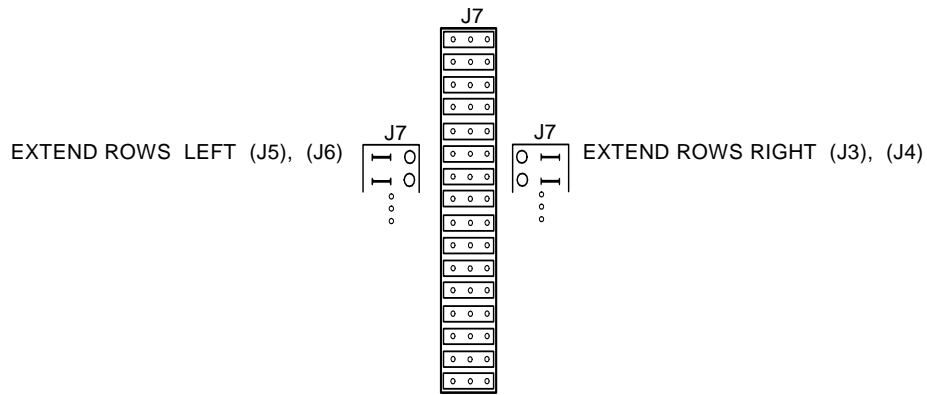

If you plan to extend rows *left*, to J5 and J6, place two 2x8 jumpers as shown at right.

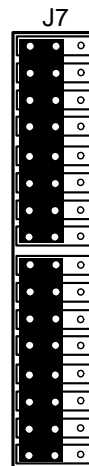

If you plan to extend rows *right*, to J3 and J4, place two 2x8 jumpers as shown at right.

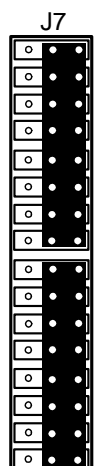

Placing Row Access Jumpers on the 34934C-002 Configuration Block The jumpers in 3x16 jumper block J8 (at lower board center) determine if row connections can be made from the male D-Sub connector P2 (i.e. they “enable” the row signal connection points at this D-sub).

These “row connections” are the traditional access points from field wiring to the matrix rows. In practice, your arrangement of test instrumentation and DUT test points will determine if you wish to make row connections at the D-sub, at the blue 20-pin extension connectors, or both.

Setting these jumpers provides you the flexibility to plan how to route your custom cabling.

The following illustration shows the jumper block J8, along with the relevant guidance provided on the board’s silk-screen for jumper placement.

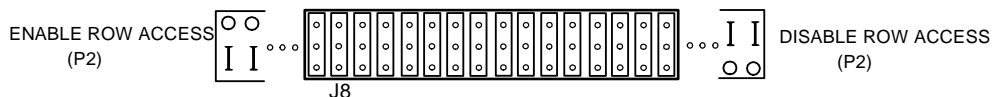

If you plan to connect row signals to D-sub connector P2, place two 2x8 jumpers on block J8, as shown below.

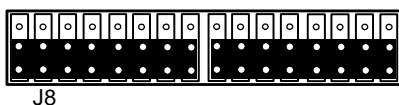

If you do not need to connect row signals to D-sub connector P2, place two 2x8 jumpers on block J8, as shown below.

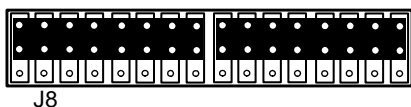

By not routing signals to the D-sub connectors, you avoid adding their extra capacitance.

Placing Row Setting Jumpers on the 34934C-002 Configuration Block

The jumpers in 3x16 jumper blocks J 15 and J16 (left and right of lower board center) set the row depth (i.e. 8-rows or 16-rows) for the expanded matrix. In conjunction with the CONFIG jumpers, these jumpers set the matrix configuration.

The following illustration shows jumper blocks J15 and J16, along with the relevant guidance provided on the board's silk-screen for jumper placement.

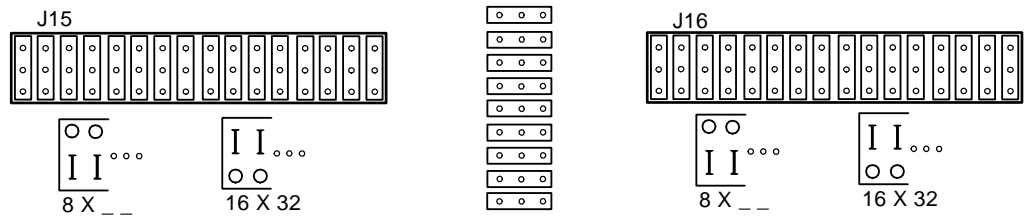

For a base configuration of 8x32, place two 2x8 jumpers *on each of* blocks J15 and J16, as shown below.



Placing Safety Interlock Continuity Jumpers on the 34934C-002 Configuration Block

At each side of the configuration block are a pair of 20-pin extension headers. On the right side are labeled J3 and J4; on the left side are J5 and J6. In all cases, pins 19 and 20 are the safety interlock pins.

These headers provide for row extension and row signal access, depending on the placement of the jumpers in J7. You must have set the jumpers to extend rows either to the left or right side of the configuration block (see “[Placing Row Extension Jumpers on the 34934C-002 Configuration Block](#)” on page 100).

To provide continuity for the module’s safety interlock function, pins 19 and 20 on *both* extension headers on the selected side (left or right) must be shorted.

- For each of these headers, install one of the supplied keyed 20-pin terminators securely in that header, as shown below.

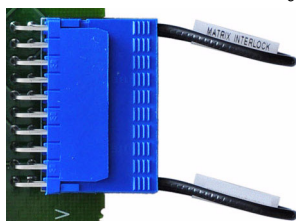

The supplied terminators incorporate both the shorting jumper for pins 19 and 20 and a jumper precluding connection to pins 1 and 2.

- The extension headers on the opposite side of the 34934C-002 do not require a safety interlock terminator; these will be hidden by the configuration block’s cover.

34934C-002 Configuration Block: Wiring

The next two subsections outline options for making row and column wiring connections to the configuration block.

Extension Header (Row Signal) Wiring to the 34934C-002

Below is an illustration of the possible locations for making row signal connections to the 34934T-002

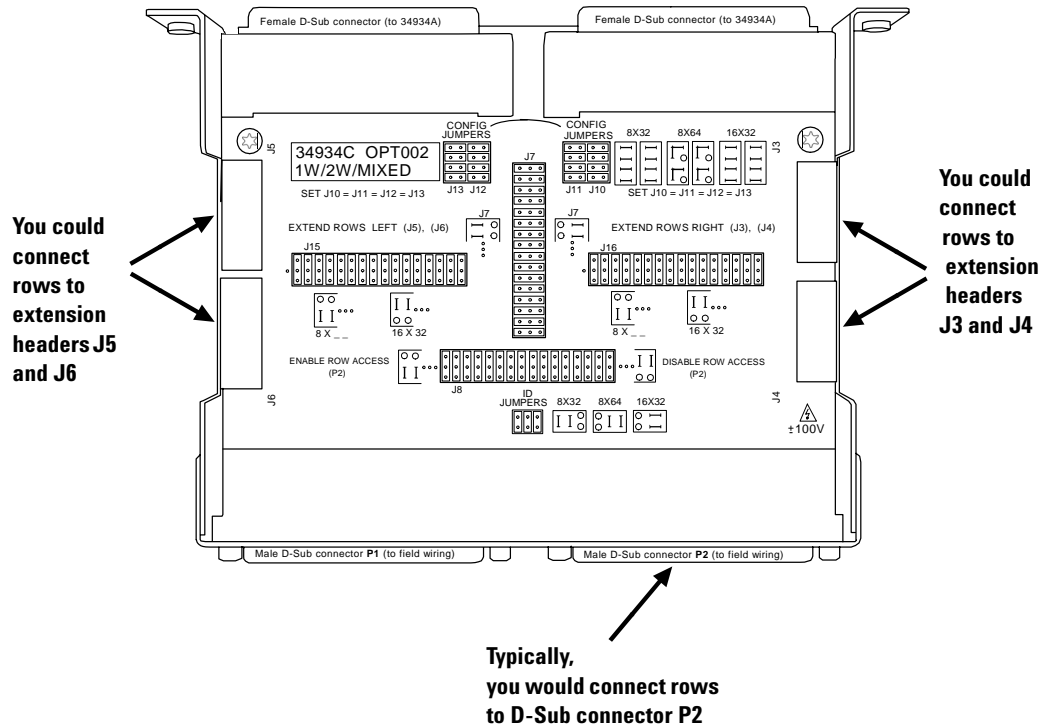

Typically, you could make both row and column connections to each module by fabricating custom cabling terminating in female D-Sub connectors. These attach to the configuration block's male D-Sub connectors P1 and P2. For 8x32, all rows connect to P2.

Alternately, you may choose to connect only columns (typically test points on your DUT) to the D-Subs. There may be physical or electrical advantages in making your *row* connections (typically measurement devices) to the configuration block's blue extension connectors J3, J4, J5 and J6. To provide this flexibility, two extension headers are provided on each side of the configuration block.

You must have set the jumpers (in ["Placing Row Extension Jumpers on the 34934C-002 Configuration Block"](#) on page 100) to extend rows to two of the four headers. We'll call these the "live" headers.

In “Placing Safety Interlock Continuity Jumpers on the 34934C-002 Configuration Block” on page 103, you will have installed the supplied blue terminators in the live headers on the configuration block.

You can now make row connections to these headers, by utilizing the central 16 pins (3-18) on the snap-in terminators. The extension header’s supplied terminator is shown below. Pay careful attention to the polarizing notches for identification of pin 1:

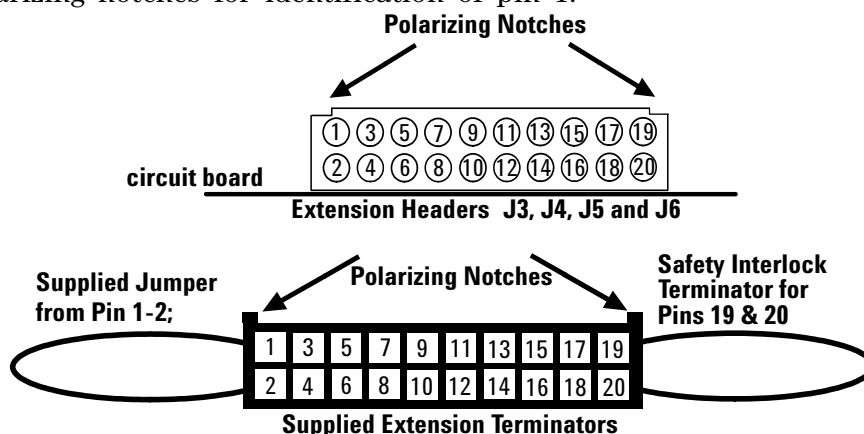

You must fabricate custom cabling to make row signal connections to the central 16 pins (3-18) of these headers, using the pin assignments below. The supplied blue terminators accommodate 22 AWG coated wire, fitted to “crimp-to-wire” contacts with latch tabs (FCI part #76357-301LF or equivalent).

34934C-002: Extension Header Pin Assignments for 8x32

Headers J4, J5				Headers J3, J6			
Description	Pin	Description	Pin	Description	Pin	Description	Pin
No connect	1	No connect	2	No connect	1	No connect	2
R1H	3	R1H	4	R5H	3	R5H	4
R1L	5	R1L	6	R5L	5	R5L	6
R2H	7	R2H	8	R6H	7	R6H	8
R2L	9	R2L	10	R6L	9	R6L	10
R3H	11	R3H	12	R7H	11	R7H	12
R3L	13	R3L	14	R7L	13	R7L	14
R4H	15	R4H	16	R8H	15	R8H	16
R4L	17	R4L	18	R8L	17	R8L	18
IL1	19	IL2	20	IL3	19	IL4	20

Note that each row signal (R1 through R8 (H,L) is routed out on two pins on the extension headers. You can make row signal connections to either row (upper, lower) of the connector.

If you are going to create an expanded-row matrix using multiple modules and configuration blocks, plan your wiring placement for each configuration block carefully, to allow for a daisy-chain interconnection between configuration blocks—in addition to any row wiring you may connect to the expansion headers. This interconnection is illustrated in “Arranging Multiple 34934A Modules with Configuration Blocks” on page 160.

34934C-002 D-Sub Connectors: Pin Assignments for 8x32 (base configuration)

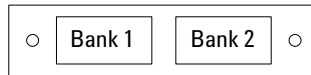

For orientation, the male D-sub connector end of the configuration block is facing you.

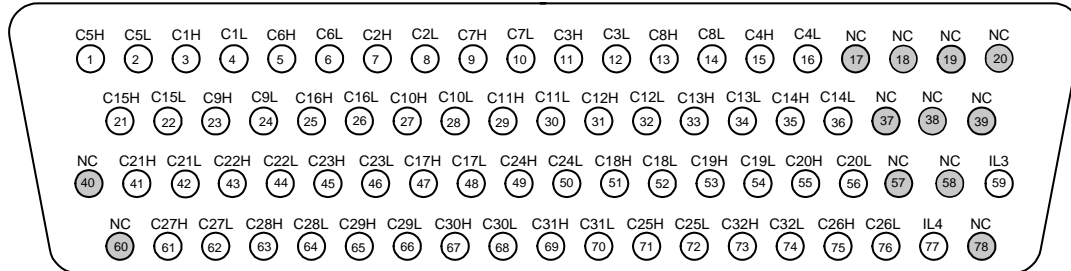

78-Pin D-Sub Male Connector

Bank 1 (P1)

Description	Pin	Description	Pin	Description	Pin	Description	Pin	Description	Pin	Description	Pin
IL3	59	C1H	3	C9H	23	C17H	47	C25H	71	No connect	17
IL4	77	C1L	4	C9L	24	C17L	48	C25L	72	No connect	18
		C2H	7	C10H	27	C18H	51	C26H	75	No connect	19
		C2L	8	C10L	28	C18L	52	C26L	76	No connect	20
		C3H	11	C11H	29	C19H	53	C27H	61	No connect	37
		C3L	12	C11L	30	C19L	54	C27L	62	No connect	38
		C4H	15	C12H	31	C20H	55	C28H	63	No connect	39
		C4L	16	C12L	32	C20L	56	C28L	64	No connect	40
		C5H	1	C13H	33	C21H	41	C29H	65	No connect	57
		C5L	2	C13L	34	C21L	42	C29L	66	No connect	58
		C6H	5	C14H	35	C22H	43	C30H	67	No connect	60
		C6L	6	C14L	36	C22L	44	C30L	68	No connect	78
		C7H	9	C15H	21	C23H	45	C31H	69		
		C7L	10	C15L	22	C23L	46	C31L	70		
		C8H	13	C16H	25	C24H	49	C32H	73		
		C8L	14	C16L	26	C24L	50	C32L	74		

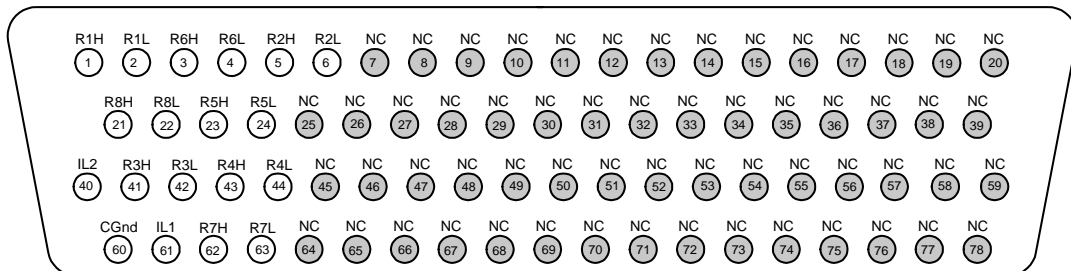

78-Pin D-Sub Male Connector

Bank 2 (P2)

Description	Pin	Description	Pin	Description	Pin	Description	Pin	Description	Pin	Description	Pin
R1H	1	No connect	7	No connect	25	No connect	45	No connect	64	IL1	61
R1L	2	No connect	8	No connect	26	No connect	46	No connect	65	IL2	40
R2H	5	No connect	9	No connect	27	No connect	47	No connect	66	Com Gnd	60
R2L	6	No connect	10	No connect	28	No connect	48	No connect	67		
R3H	41	No connect	11	No connect	29	No connect	49	No connect	68		
R3L	42	No connect	12	No connect	30	No connect	50	No connect	69		
R4H	43	No connect	13	No connect	31	No connect	51	No connect	70		
R4L	44	No connect	14	No connect	32	No connect	52	No connect	71		
R5H	23	No connect	15	No connect	33	No connect	53	No connect	72		
R5L	24	No connect	16	No connect	34	No connect	54	No connect	73		
R6H	3	No connect	17	No connect	35	No connect	55	No connect	74		
R6L	4	No connect	18	No connect	36	No connect	56	No connect	75		
R7H	62	No connect	19	No connect	37	No connect	57	No connect	76		
R7L	63	No connect	20	No connect	38	No connect	58	No connect	77		
R8H	21			No connect	39	No connect	59	No connect	78		
R8L	22										

34934C-001 D-Sub Connectors: Wiring for 8x32

NOTE

The D-Sub connector pin assignments for the 34934C-001 configuration block mirror those shown for the 34934A module. However—for safety reasons—the *D-Sub pin assignments for the 34934C-002 configuration block* **do not mirror those for the 34934A module**. Please consult the correct configuration sections for wiring to the D-Sub connectors.

Safety Interlock Continuity While wiring to the 34934C-002's D-Sub connectors, you *must* make the following connections—in addition to the 8x32 row and column connections—to provide for safety interlock continuity:

Short: Pin 59 to Pin 77 on Bank 1

Short: Pin 40 to Pin 61 on Bank 2

Configuring an 8x32 Matrix by Direct Wiring

34934A module D-Sub Connectors: 8x32 Pin Assignments

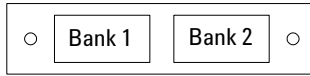

For orientation, the D-sub connector end of the module is facing you.

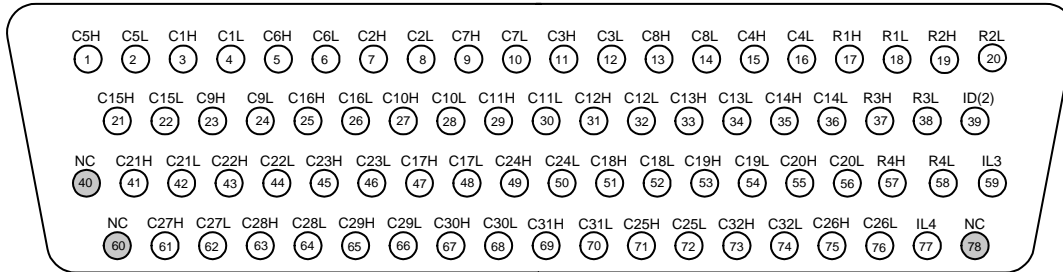

78-Pin D-Sub Male Connector

Bank 1

Description	Pin	Description	Pin	Description	Pin	Description	Pin	Description	Pin	Description	Pin
R1H	17	C1H	3	C9H	23	C17H	47	C25H	71	ID2	39
R1L	18	C1L	4	C9L	24	C17L	48	C25L	72	IL3	59
R2H	19	C2H	7	C10H	27	C18H	51	C26H	75	IL4	77
R2L	20	C2L	8	C10L	28	C18L	52	C26L	76	No connect	40
R3H	37	C3H	11	C11H	29	C19H	53	C27H	61	No connect	60
R3L	38	C3L	12	C11L	30	C19L	54	C27L	62	No connect	78
R4H	57	C4H	15	C12H	31	C20H	55	C28H	63		
R4L	58	C4L	16	C12L	32	C20L	56	C28L	64		
		C5H	1	C13H	33	C21H	41	C29H	65		
		C5L	2	C13L	34	C21L	42	C29L	66		
		C6H	5	C14H	35	C22H	43	C30H	67		
		C6L	6	C14L	36	C22L	44	C30L	68		
		C7H	9	C15H	21	C23H	45	C31H	69		
		C7L	10	C15L	22	C23L	46	C31L	70		
		C8H	13	C16H	25	C24H	49	C32H	73		
		C8L	14	C16L	26	C24L	50	C32L	74		

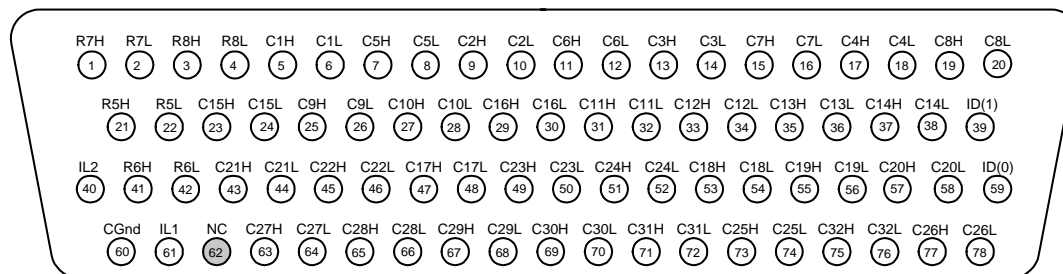

78-Pin D-Sub Male Connector

Bank 2

Description	Pin	Description	Pin	Description	Pin	Description	Pin	Description	Pin	Description	Pin
R5H	21	C1H	5	C9H	25	C17H	47	C25H	73	ID1	39
R5L	22	C1L	6	C9L	26	C17L	48	C25L	74	ID0	59
R6H	41	C2H	9	C10H	27	C18H	53	C26H	77	IL1	61
R6L	42	C2L	10	C10L	28	C18L	54	C26L	78	IL2	40
R7H	1	C3H	13	C11H	31	C19H	55	C27H	63	Com Gnd	60
R7L	2	C3L	14	C11L	32	C19L	56	C27L	64	No connect	62
R8H	3	C4H	17	C12H	33	C20H	57	C28H	65		
R8L	4	C4L	18	C12L	34	C20L	58	C28L	66		
		C5H	7	C13H	35	C21H	43	C29H	67		
		C5L	8	C13L	36	C21L	44	C29L	68		
		C6H	11	C14H	37	C22H	45	C30H	69		
		C6L	12	C14L	38	C22L	46	C30L	70		
		C7H	15	C15H	23	C23H	49	C31H	71		
		C7L	16	C15L	24	C23L	50	C31L	72		
		C8H	19	C16H	29	C24H	51	C32H	75		
		C8L	20	C16L	30	C24L	52	C32L	76		

34934A Module D-Sub Connectors: 8x32 Wiring

When wiring directly to the 34934A's D-Sub connectors, you *must* make the following connections—in addition to row and column connections—to configure the 8x32 matrix (matrices):

Module Configuration: The connections listed below short the rows in the 34934A's native 4x4x32 configuration to create the 8x32 MH and 8x32 ML matrices.

To Create This Column #	Short This Pin on Bank 1...	...To This Pin on Bank 2	To Create This Column #	Short This Pin on Bank 1...	...To This Pin on Bank 2
C1H	3	5	C17H	47	47
C1L	4	6	C17L	48	48
C2H	7	9	C18H	51	53
C2L	8	10	C18L	52	54
C3H	11	13	C19H	53	55
C3L	12	14	C19L	54	56
C4H	15	17	C20H	55	57
C4L	16	18	C20L	56	58
C5H	1	7	C21H	41	43
C5L	2	8	C21L	42	44
C6H	5	11	C22H	43	45
C6L	6	12	C22L	44	46
C7H	9	15	C23H	45	49
C7L	10	16	C23L	46	50
C8H	13	19	C24H	49	51
C8L	14	20	C24L	50	52
C9H	23	25	C25H	71	73
C9L	24	26	C25L	72	74
C10H	27	27	C26H	75	77
C10L	28	28	C26L	76	78
C11H	29	31	C27H	61	63
C11L	30	32	C27L	62	64
C12H	31	33	C28H	63	65
C12L	32	34	C28L	64	66
C13H	33	35	C29H	65	67
C13L	34	36	C29L	66	68
C14H	35	37	C30H	67	69
C14L	36	38	C30L	68	70
C15H	21	23	C31H	69	71
C15L	22	24	C31L	70	72
C16H	25	29	C32H	73	75
C16L	26	30	C32L	74	76

Note that these connections require wires run *between* the two D-Sub connectors. You may make these connections near your test instrumentation or DUT, or near the D-Sub ends of your custom cabling.

Module ID: The open pins listed below allow the 34980A mainframe to recognize the 8x32 matrix configuration.

Ground: Pin 39 on Bank 1 (ID bit 2)
 Ground: Pin 39 on Bank 2 (ID bit 1)
 Leave Open: Pin 59 on Bank 2 (ID bit 0)

Safety Interlock Continuity: The connections listed below provide for safety interlock continuity.

Short: Pin 59 to Pin 77 on Bank 1

Short: Pin 40 to Pin 61 on Bank 2

NOTE

If you use the 34934C-002 Configuration Block—in conjunction with the 34934A module—to make wiring connections, the additional **Module Configuration** and **Module ID** connections are *not required*. Those connections are made within the hardware of the configuration block. You would need only make the **Safety Interlock Continuity** connections.

8x64 Matrix Configuration

To create an 8x64 matrix, you may connect your field wiring to the 34934A by three methods:

Terminal Block You can use terminal block 34934T-002. The terminal block connects to the 34934A's two D-Sub connectors; it provides 12 blocks of 12 screw terminals each, and an *8x64 removable overlay* (supplied with the 34934T-002) which provides guidance for field wiring the 8x64 matrices. Follow these sections in order to configure and wire the terminal block:

- “34934T-002 Terminal Block: 8x64 Jumper Configuration” on page 114
- “34934T-002 Terminal Block: 8x64 Jumper Configuration” on page 114
- “34934T-002 Terminal Block: 8x64 Wiring” on page 116

Configuration Block You can use configuration block 34934C-001. Follow these sections in order to configure and wire the configuration block:

- “34934C-002 Configuration Block: Layout” on page 118
- “34934C-002 Configuration Block: 8x64 Jumper Configuration” on page 119
- “34934C-002 Configuration Block: Wiring” on page 125

NOTE

Use of the 34934C-002 precludes use of a piggy-backed 34934T-002 terminal block for field wiring connections; the combination is not mechanically reliable.

Direct Wiring You can wire directly to the module's D-Sub connectors using custom cabling. You will have to short specific pins on and between the D-Sub connectors to create the 8x64 configuration. Review *both* these sections *before* wiring to the module's D-Subs:

- “34934A module D-Sub Connectors: 8x64 Pin Assignments” on page 129
- “34934A Module D-Sub Connectors: 8x64 Wiring” on page 130

Configuring an 8x64 Matrix using a Terminal Block

34934T-002 Terminal Block: 8x64 Layout

This terminal block with screw-type connections is labeled with the model number and the abbreviated module name. In addition, space is available on the label for you to write the slot number.

The *34980A Product Reference* CD (shipped with the module) contains a 34934T Wiring Log for you to document your wiring configuration for this module. You can open the wiring log file in Microsoft® Excel® or Adobe® Acrobat® format.

This terminal block's *8x64 removable overlay* shows the row and column terminals for the 8x64 matrix configuration:

Wire Size:
20 AWG (Typical)

18 AWG (Screw
Terminal Max)

24AWG (Max if
all 144 lines are used)

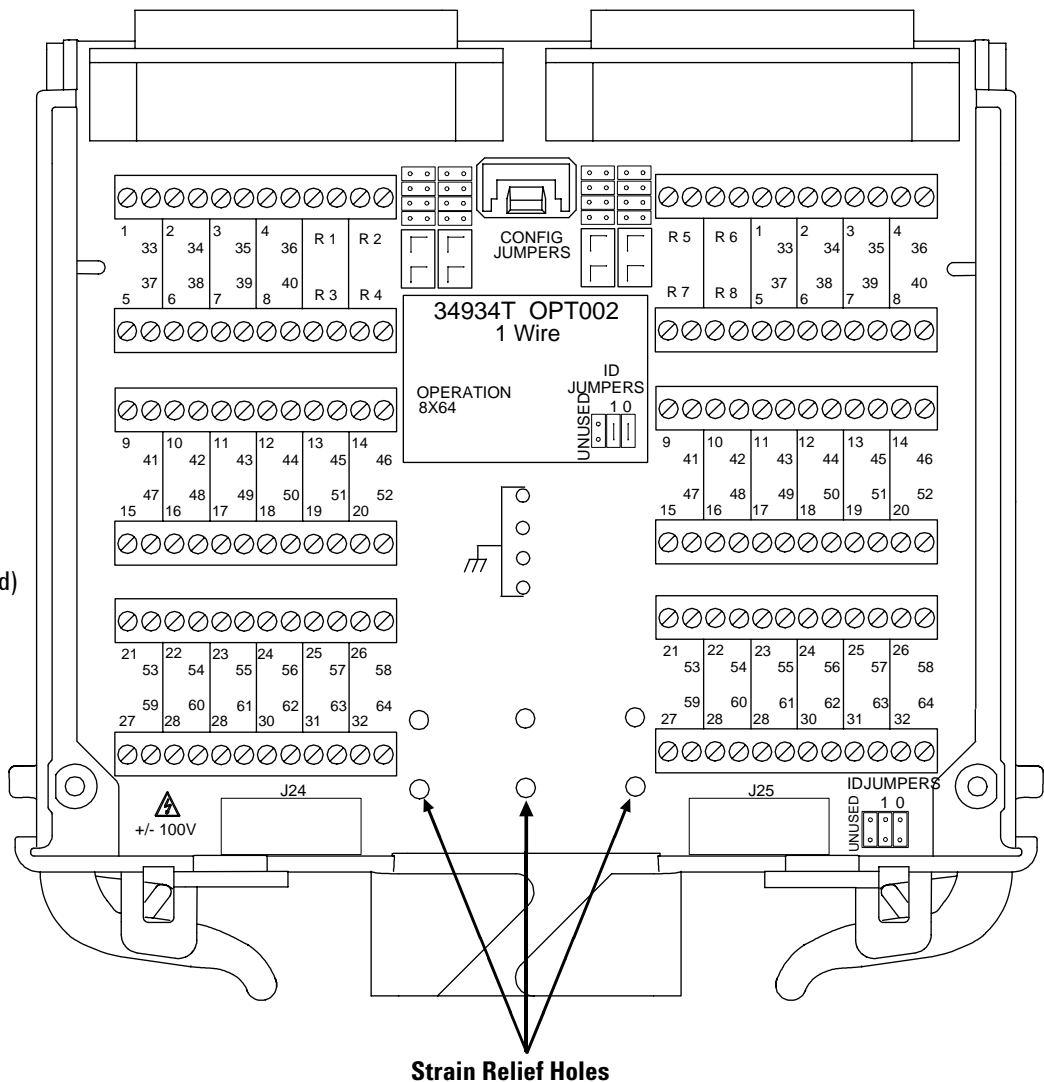

Note the six strain relief holes provided in the terminal block PCB. See the following page for instructions on providing wiring strain relief.

34934T-002 Terminal Block: 8x64 Terminal Wiring Options

On the 34934T-002 terminal block, there are redundant sets of terminals provided for columns 1-64, one set on each side of the block. The column terminals on each side are shorted by traces in the block to their like-labeled counterparts on the other; you may make any column connection to the appropriate terminal on either side.

Terminal block strain relief

To reduce strain on the wiring at the terminals and maintain connection reliability, a strain relief feature has been incorporated into the terminal block design. Six holes have been placed near the lower edge of the circuit board, lined up with holes in the terminal block's bottom cover, as seen on [“34934T-002 Terminal Block: 8x64 Layout”](#) on page 112.

To use this feature:

- 1 Once all jumpers are installed and wiring is connected to the terminals, arrange the wires leading away from the terminal block in two bundles. This is easiest if the left bundle leads to the terminals on the left side of the block, and conversely for the right side.
- 2 Insert a cable tie (tie-wrap, zip-tie) down through each of the four outside holes in the PCB, continuing down through the holes in the terminal block's bottom cover.
- 3 Route these cable ties up through the center holes in the bottom cover and PCB.
- 4 Close and tighten the cable ties as required, and remove any excess so that it does not interfere with cover closure.

The completed bundles are shown below.

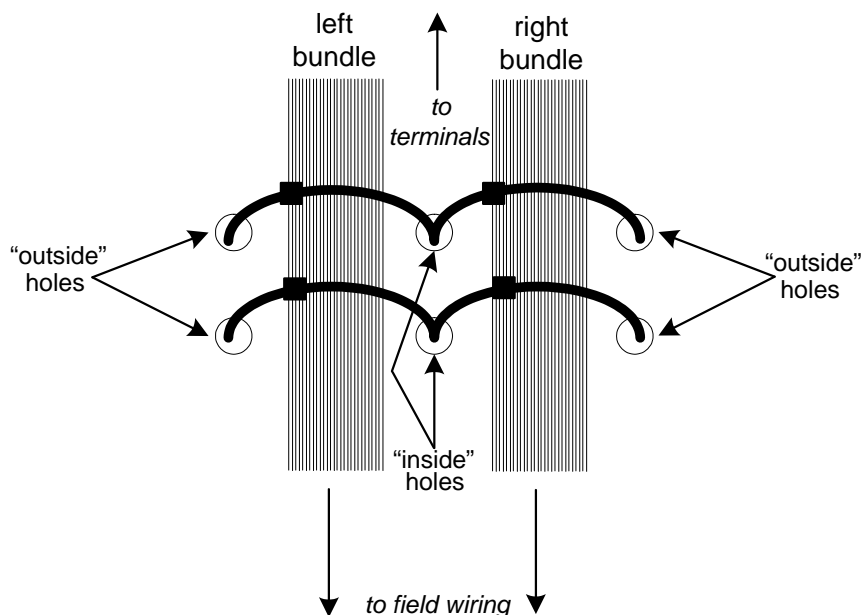

34934T-002 Terminal Block: 8x64 Jumper Configuration

This terminal block has three types of jumpers which must be connected to configure the 8x64 matrix (matrices):

- **CONFIG Jumpers:** place these 2-pin jumpers *identically on all four* 4x2 blocks of jumper pins located near the board's female D-Sub connectors, as shown.
- **ID Jumpers:** place these 2-pin jumpers on a 2x3 block of jumper pins on the lower right corner of the board, as shown.
- **Safety Interlock Continuity Jumpers:** place the supplied pre-wired terminators or equivalent custom wiring on the two 20-pin extension headers at the bottom of the terminal block, as shown.

Placing CONFIG Jumpers for 8x64 The CONFIG jumper area—shown below with jumpers removed—has an illustration below it (on the *8x64 removable overlay*) providing jumper placement guidance for 8x64 matrix configuration.

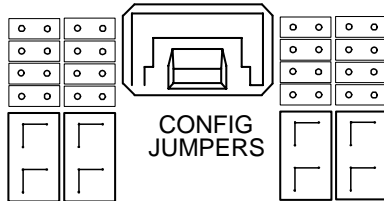

- 1 Place eight vertically positioned jumpers as shown below.

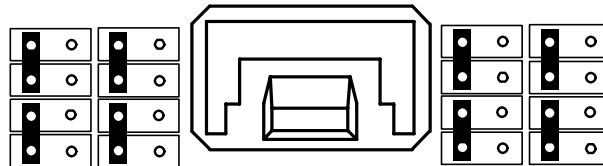

- 2 Then *stack* eight horizontally positioned jumpers *above* the first set of eight, as shown below.

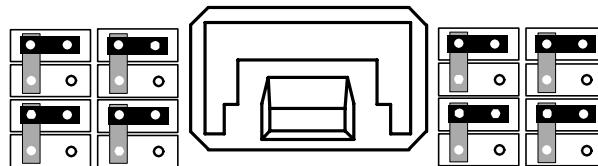

Placing ID Jumpers for 8x64 The ID jumpers allow the 34980A to recognize the 8x64 matrix configuration upon mainframe bootup. Jumper placement guidance is provided (on the *8x64 removable overlay*) as shown below left; the ID jumper block is shown at right with jumpers removed.

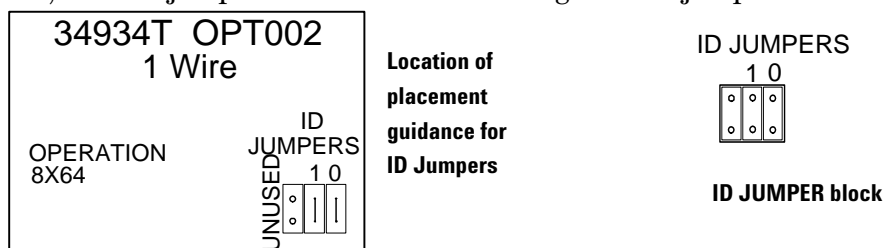

To set the correct ID code for 8x64, place two vertically positioned jumpers as shown below.

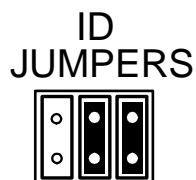

Placing Safety Interlock Continuity Jumpers for 8x64 At the bottom (end opposite the D-Sub connectors) of the terminal block are two 20-pin extension headers—marked J24 and J25 on the circuit board. These headers provide access to the module's rows. Pins 19 and 20 on each header must be shorted to provide continuity for the module's safety interlock function.

Two keyed 20-pin terminators are supplied for providing safety interlock continuity. Install the terminators securely in the headers, as shown below.

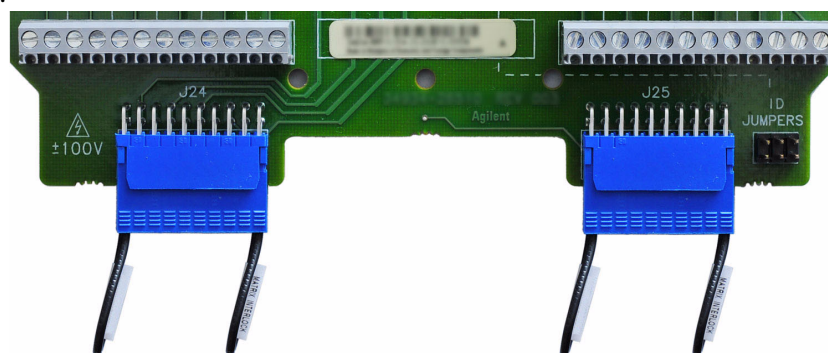

The supplied terminators incorporate both the shorting jumper for pins 19 and 20 and a jumper precluding connection to pins 1 and 2. Detailed pin diagrams for these terminators are provided on [page 117](#).

34934T-002 Terminal Block: 8x64 Wiring

Once the required jumpers have been placed to configure the terminal block as 8x64, you are ready to make row and column connections to the terminal block.

You may connect to the module's rows and columns by wiring to the screw terminals marked C1 through C64 (H, L) and R1 through R8 (H, L) on the silk-screen (see [“34934T-002 Terminal Block: 8x64 Layout”](#) on page 112). The combined weight of these wires can create significant strain on the wiring; to minimize this see [“Terminal block strain relief”](#) on page 113.

However, you may prefer to use physically separate cabling for the row connections (e.g. if you connect your DUT to the columns and your measurement device(s) to the rows). The terminal block's extension headers J24 and J25 provide access to the rows; you can make row connections to the central 16 terminals (pins 3-18) on the supplied terminators you installed in [“Placing Safety Interlock Continuity Jumpers for 8x64”](#) on page 115.

Below is an illustration of the possible locations for making row signal connections to the 34934T-002:

You can connect row signals to the screw terminals here...

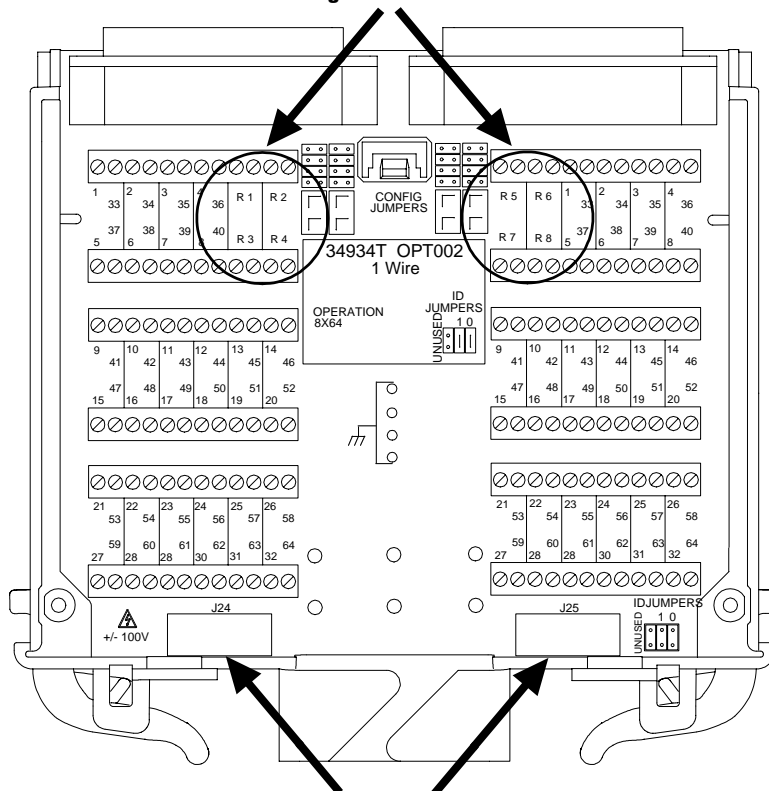

...or to the central 16 pins of extension headers J24 or J25 here.

The following subsection outlines how to make row connections to extension headers J24 and J25.

Extension Header (Row Signal) Wiring for 8x64 The position of extension headers J24 and J25 are marked on the 34934T-002's silk-screen. Oriented with the terminal side of the board up, the pin numbers for these headers are shown below.

Extension Headers J24 and J25

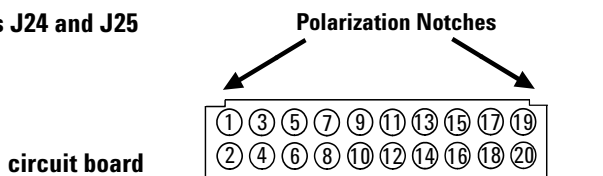

The supplied 20-pin terminators are identical, but the pin assignments for 8x64 are not (rows 1-4 are on J24; rows 5-8 are on J25). The terminal numbers—corresponding to the headers—are shown below. *Pay careful attention to the indexing keys on the connectors, to correctly identify terminal #1.*

20-Pin Terminators for J24 and J25

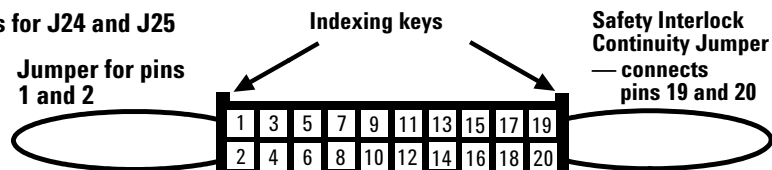

You must fabricate custom cabling to make row signal connections to the central 16 pins (3-18) of these headers, using the pin assignments below. The supplied blue terminators accommodate 22 AWG coated wire, fitted to “crimp-to-wire” contacts with latch tabs (FCI part #76357-301LF or equivalent).

34934T-002: Extension Header Pin Assignments for 8x64

Headers J24				Headers J25			
Description	Pin	Description	Pin	Description	Pin	Description	Pin
No connect	1	No connect	2	No connect	1	No connect	2
R1	3	R1	4	R5	3	R5	4
No connect	5	No connect	6	No connect	5	No connect	6
R2	7	R2	8	R6	7	R6	8
No connect	9	No connect	10	No connect	9	No connect	10
R3	11	R3	12	R7	11	R7	12
No connect	13	No connect	14	No connect	13	No connect	14
R4	15	R4	16	R8	15	R8	16
No connect	17	No connect	18	No connect	17	No connect	18
IL1	19	IL2	20	IL3	19	IL4	20

Note that each row signal (R1 through R8 (H,L)) is routed out on four pins on the extension headers. You can make row signal connections to either row (upper, lower) of the connector.

If you are going to create an expanded-row matrix using multiple modules and terminal blocks, plan your wiring placement for each terminal block carefully, to allow for a daisy-chain interconnection between terminal blocks—in addition to any row wiring you may connect to the expansion headers. This interconnection is illustrated in [“Arranging Multiple 34934A Modules with Terminal Blocks”](#) on page 158.

Configuring an 8x64 Matrix using a Configuration Block

34934C-002 Configuration Block: Layout

This configuration block is labeled with the model number and the abbreviated module name.

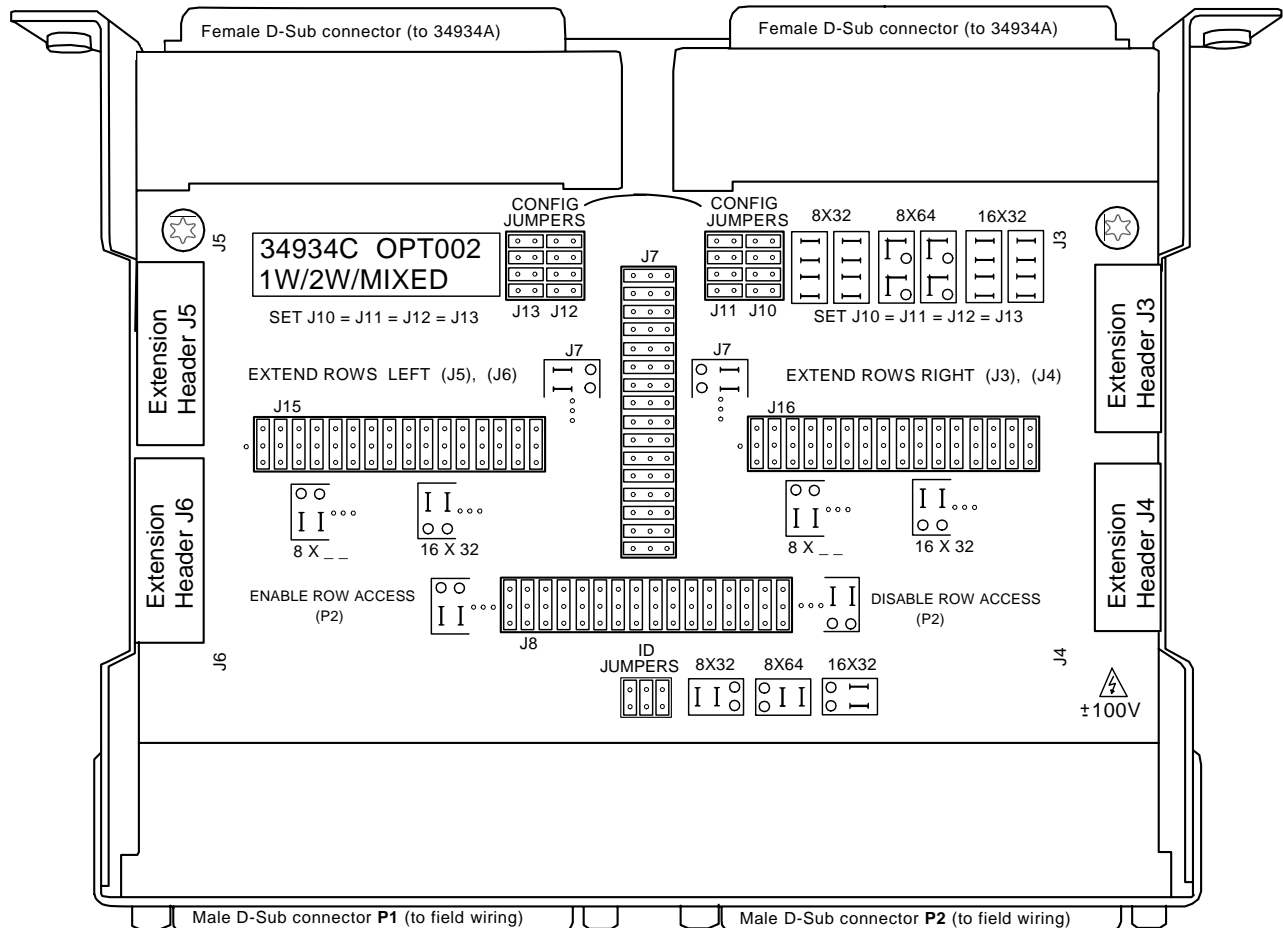

Note five types of on-board jumpers you'll have to set to configure this board; some will be familiar from the configuration descriptions of the *terminal blocks*, but some are new. Instructions for setting these are provided in “[34934C-002 Configuration Block: 8x64 Jumper Configuration](#)” on page 119.

- ID Jumpers
- CONFIG Jumpers (J10, J11, J12 and J13)
- Row Extension Jumpers (J7)
- Row Access Jumpers (J8)
- Row Setting Jumpers (J15 and J16)

Also note the four extension headers (J3, J4, J5 and J6). Instructions for wiring to these are provided in “[34934C-002 Configuration Block: Wiring](#)” on page 125.

34934C-002 Configuration Block: 8x64 Jumper Configuration

The configuration block has five types of jumpers which must be connected to configure it for use in an expanded 4-row matrix. In this section, you will place:

- **ID Jumpers:** place these 2-pin jumpers on a 2x3 block of jumper pins near the bottom center of the board. See [“Placing ID Jumpers on the 34934C-002 Configuration Block for 8x64”](#) on page 120.
- **CONFIG Jumpers:** place these 2-pin jumpers *identically on all four* 4x2 blocks of jumper pins located near the board’s female D-Sub connectors. See [“Placing CONFIG Jumpers on the 34934C-002 Configuration Block for 8x64”](#) on page 120.
- **Row Extension Jumpers:** place these 16-pin jumpers on a 16x3 block (J7) of jumper pins at the board’s center. See [“Placing Row Extension Jumpers on the 34934C-002 Configuration Block”](#) on page 121.
- **Row Access Jumpers:** place these 16-pin jumpers on a 3x16 block of jumper pins located just above the ID Jumpers. See [“Placing Row Access Jumpers on the 34934C-002 Configuration Block”](#) on page 122.
- **Safety Interlock Continuity Jumpers:** place the supplied pre-wired terminators on the four 20-pin extension headers at the sides of the configuration block. See [“Placing Safety Interlock Continuity Jumpers on the 34934C-002 Configuration Block”](#) on page 124.

Placing ID Jumpers on the 34934C-002 Configuration Block for 8x64 The ID jumpers allow the 34980A to recognize the base matrix configuration used by the 34934C-002, upon mainframe bootup. The ID jumpers are placed in a 2x3 jumper block, located below jumper block J8. Jumper placement guidance is provided on the configuration block’s silk-screen, to the right of the jumpers:

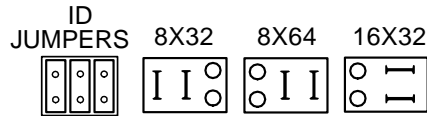

To set the correct ID code for 8x64, place two vertically positioned jumpers in the right position, as shown below.



Placing CONFIG Jumpers on the 34934C-002 Configuration Block for 8x64 The CONFIG jumper area—shown below with jumpers removed—has an illustration to its right providing jumper placement guidance for the 8x32, 8x64 and 16x32 base matrix configurations.

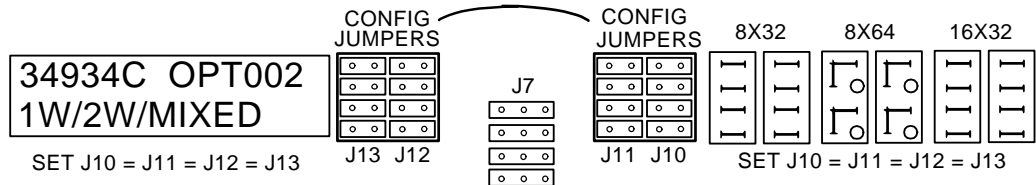

To set the CONFIG jumpers for 8x64:

- 1 Place eight horizontally positioned jumpers as shown below.

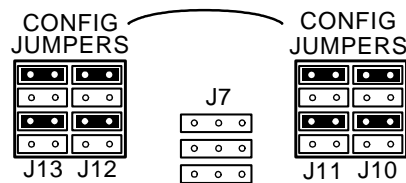

- 2 Then stack eight vertically positioned jumpers as shown below.

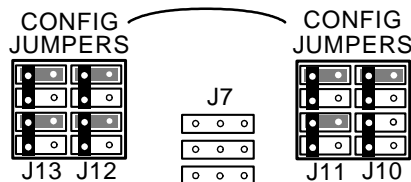

Placing Row Extension Jumpers on the 34934C-002 Configuration Block The jumpers in 16x3 jumper block J7 (at board center) determine if row connections can be made from the left or right side of the board (i.e. they “extend” the row signal connection points out to *only one* of the two pairs of blue 20-pin connectors at the sides of the configuration block).

Note that “row connections” at minimum include the connections between modules in the matrix, but may also include your access from field wiring to the matrix rows.

Setting these jumpers provides you the flexibility to plan how to route your custom cabling, depending on slot placement of the individual 34934A modules and their corresponding 34934C-002 blocks.

The following illustration shows the jumper block J7, along with the relevant guidance provided on the board’s silk-screen for jumper placement:

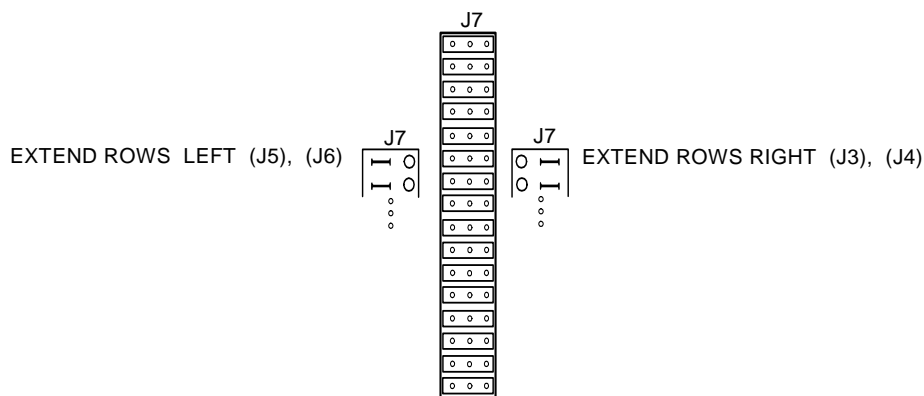

If you plan to extend rows *left*, to J5 and J6, place two 2x8 jumpers as shown at right.

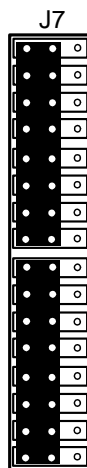

If you plan to extend rows *right*, to J3 and J4, place two 2x8 jumpers as shown at right.

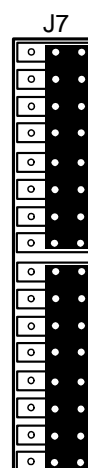

Placing Row Access Jumpers on the 34934C-002 Configuration Block The jumpers in 3x16 jumper block J8 (at lower board center) determine if row connections can be made from the male D-Sub connector P2 (i.e. they “enable” the row signal connection points at this D-sub).

These “row connections” are the traditional access points from field wiring to the matrix rows. In practice, your arrangement of test instrumentation and DUT test points will determine if you wish to make row connections at the D-sub, at the blue 20-pin extension connectors, or both.

Setting these jumpers provides you the flexibility to plan how to route your custom cabling.

The following illustration shows the jumper block J8, along with the relevant guidance provided on the board’s silk-screen for jumper placement.

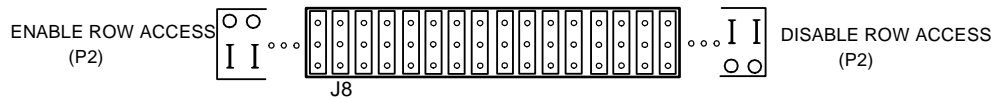

If you plan to connect row signals to D-sub connector P2, place two 2x8 jumpers on block J8, as shown below.

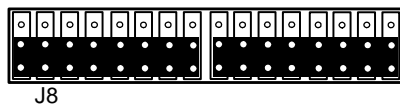

If you do not need to connect row signals to D-sub connector P2, place two 2x8 jumpers on block J8, as shown below.

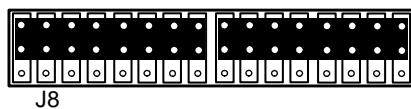

By not routing signals to the D-sub connectors, you avoid adding their extra capacitance.

Placing Row Setting Jumpers on the 34934C-002 Configuration Block

The jumpers in 3x16 jumper blocks J 15 and J16 (left and right of lower board center) set the row depth (i.e. 8-rows or 16-rows) for the expanded matrix. In conjunction with the CONFIG jumpers, these jumpers set the matrix configuration.

The following illustration shows jumper blocks J15 and J16, along with the relevant guidance provided on the board's silk-screen for jumper placement.

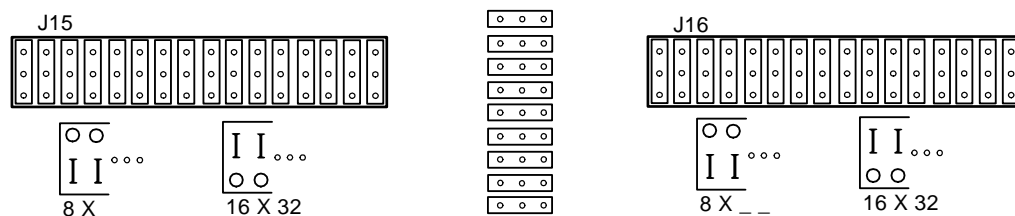

For a base configuration of 8x64, place two 2x8 jumpers *on each of* blocks J15 and J16, as shown below.



Placing Safety Interlock Continuity Jumpers on the 34934C-002 Configuration Block

Block At each side of the configuration block are a pair of 20-pin extension headers. On the right side are labeled J3 and J4; on the left side are J5 and J6. In all cases, pins 19 and 20 are the safety interlock pins.

These headers provide for row extension and row signal access, depending on the placement of the jumpers in J7. You must have set the jumpers to extend rows either to the left or right side of the configuration block (see [“Placing Row Extension Jumpers on the 34934C-002 Configuration Block”](#) on page 121).

To provide continuity for the module’s safety interlock function, pins 19 and 20 on *both* extension headers on the selected side (left or right) must be shorted.

- For each of these headers, install one of the supplied keyed 20-pin terminators securely in that header, as shown below.

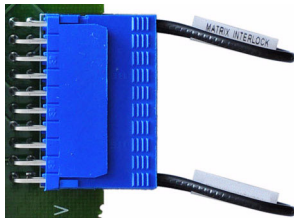

The supplied terminators incorporate both the shorting jumper for pins 19 and 20 and a jumper precluding connection to pins 1 and 2.

- The extension headers on the opposite side of the 34934C-002 do not require a safety interlock terminator; these will be hidden by the configuration block’s cover.

34934C-002 Configuration Block: Wiring

The next two subsections outline options for making row and column wiring connections to the configuration block.

Extension Header (Row Signal) Wiring to the 34934C-002

Below is an illustration of the possible locations for making row signal connections to the 34934T-002

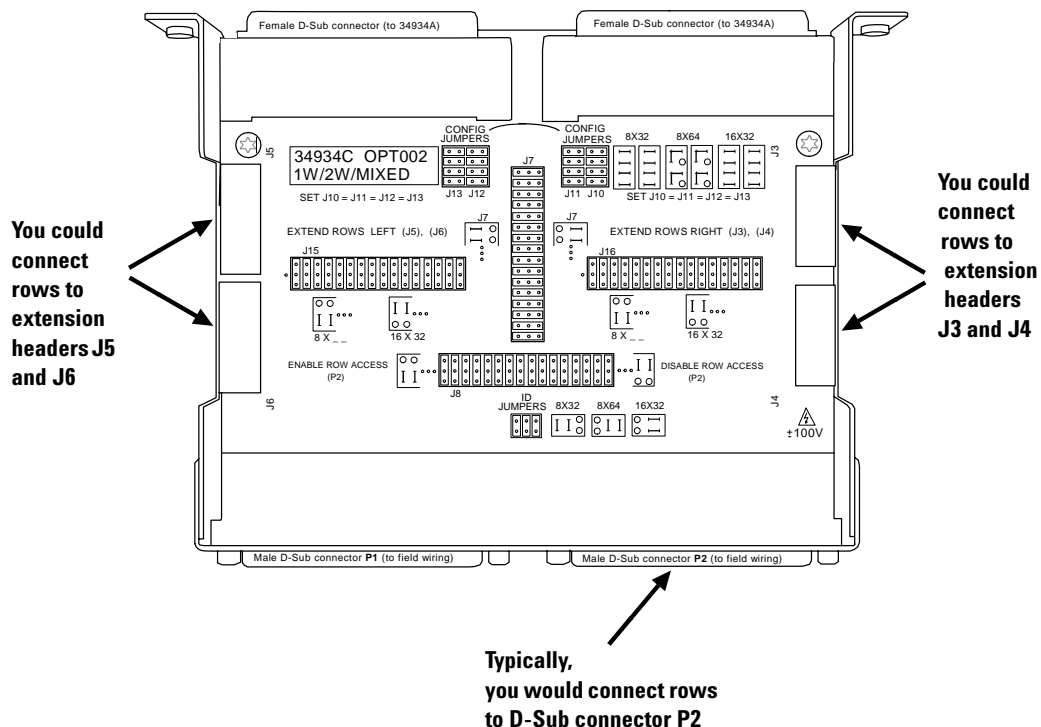

Typically, you could make both row and column connections to each module by fabricating custom cabling terminating in female D-Sub connectors. These attach to the configuration block's male D-Sub connectors P1 and P2. For 8x64, all rows connect to P2.

Alternately, you may choose to connect only columns (typically test points on your DUT) to the D-Subs. There may be physical or electrical advantages in making your *row* connections (typically measurement devices) to the configuration block's blue extension connectors J3, J4, J5 and J6. To provide this flexibility, two extension headers are provided on each side of the configuration block.

You must have set the jumpers (in "Placing Row Extension Jumpers on the 34934C-002 Configuration Block" on page 121) to extend rows to two of the four headers. We'll call these the "live" headers.

In “Placing Safety Interlock Continuity Jumpers on the 34934C-002 Configuration Block” on page 124, you will have installed the supplied blue terminators in the live headers on the configuration block.

You can now make row connections to these headers, by utilizing the central 16 pins (3-18) on the snap-in terminators. The extension header’s supplied terminator is shown below. Pay careful attention to the polarizing notches for identification of pin 1:

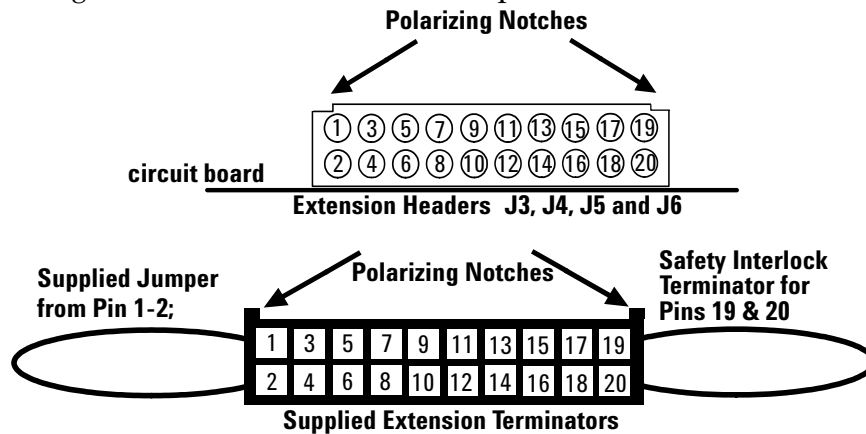

You must fabricate custom cabling to make row signal connections to the central 16 pins (3-18) of these headers, using the pin assignments below. The supplied blue terminators accommodate 22 AWG coated wire, fitted to “crimp-to-wire” contacts with latch tabs (FCI part #76357-301LF or equivalent).

34934C-002: Extension Header Pin Assignments for 8x64

Headers J4, J5				Headers J3, J6			
Description	Pin	Description	Pin	Description	Pin	Description	Pin
No connect	1	No connect	2	No connect	1	No connect	2
R1	3	R1	4	R5	3	R5	4
No connect	5	No connect	6	No connect	5	No connect	6
R2	7	R2	8	R6	7	R6	8
No connect	9	No connect	10	No connect	9	No connect	10
R3	11	R3	12	R7	11	R7	12
No connect	13	No connect	14	No connect	13	No connect	14
R4	15	R4	16	R8	15	R8	16
No connect	17	No connect	18	No connect	17	No connect	18
IL1	19	IL2	20	IL3	19	IL4	20

Note that each row signal (R1 through R8) is routed out on two pins on the extension headers. You can make row signal connections to either row (upper, lower) of the connector.

If you are going to create an expanded-row matrix using multiple modules and configuration blocks, plan your wiring placement for each configuration block carefully, to allow for a daisy-chain interconnection between configuration blocks—in addition to any row wiring you may connect to the expansion headers. This interconnection is illustrated in “Arranging Multiple 34934A Modules with Configuration Blocks” on page 160.

34934C-002 D-Sub Connectors: Pin Assignments for 8x64 (base configuration)

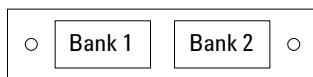

For orientation, the male D-sub connector end of the configuration block is facing you.

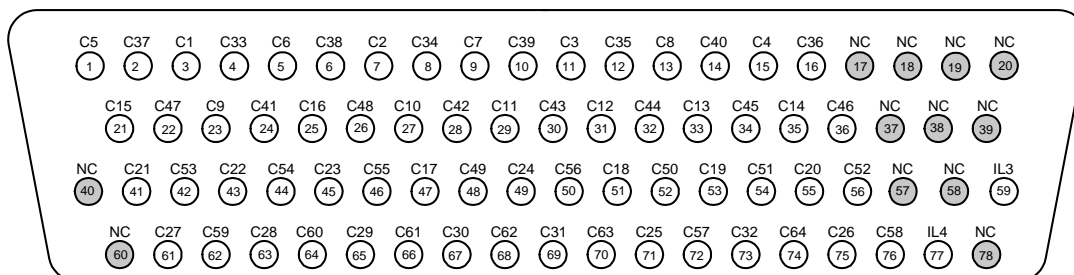

78-Pin D-Sub Male Connector
Bank 1 (P1)

Description	Pin	Description	Pin	Description	Pin	Description	Pin	Description	Pin	Description	Pin
IL3	59	C1	3	C17	47	C33	4	C49	48	No connect	17
IL4	77	C2	7	C18	51	C34	8	C50	52	No connect	18
		C3	11	C19	53	C35	12	C51	54	No connect	19
		C4	15	C20	55	C36	16	C52	56	No connect	20
		C5	1	C21	41	C37	2	C53	42	No connect	37
		C6	5	C22	43	C38	6	C54	44	No connect	38
		C7	9	C23	45	C39	10	C55	46	No connect	39
		C8	13	C24	49	C40	14	C56	50	No connect	40
		C9	23	C25	71	C41	24	C57	72	No connect	57
		C10	27	C26	75	C42	28	C58	76	No connect	58
		C11	29	C27	61	C43	30	C59	62	No connect	60
		C12	31	C28	63	C44	32	C60	64	No connect	78
		C13	33	C29	65	C45	34	C61	66		
		C14	35	C30	67	C46	36	C62	68		
		C15	21	C31	69	C47	22	C63	70		
		C16	25	C32	73	C48	26	C64	74		

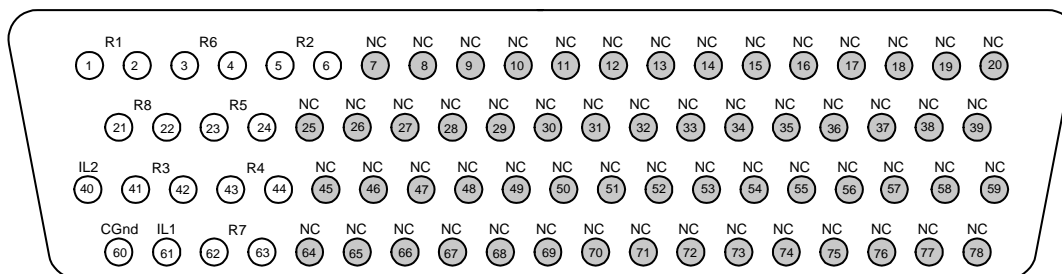

78-Pin D-Sub Male Connector
Bank 2 (P2)

Description	Pin	Description	Pin	Description	Pin	Description	Pin	Description	Pin	Description	Pin
R1	1	No connect	7	No connect	25	No connect	45	No connect	64	IL1	61
R1	2	No connect	8	No connect	26	No connect	46	No connect	65	IL2	40
R2	5	No connect	9	No connect	27	No connect	47	No connect	66	Com Gnd	60
R2	6	No connect	10	No connect	28	No connect	48	No connect	67		
R3	41	No connect	11	No connect	29	No connect	49	No connect	68		
R3	42	No connect	12	No connect	30	No connect	50	No connect	69		
R4	43	No connect	13	No connect	31	No connect	51	No connect	70		
R4	44	No connect	14	No connect	32	No connect	52	No connect	71		
R5	23	No connect	15	No connect	33	No connect	53	No connect	72		
R5	24	No connect	16	No connect	34	No connect	54	No connect	73		
R6	3	No connect	17	No connect	35	No connect	55	No connect	74		
R6	4	No connect	18	No connect	36	No connect	56	No connect	75		
R7	62	No connect	19	No connect	37	No connect	57	No connect	76		
R7	63	No connect	20	No connect	38	No connect	58	No connect	77		
R8	21			No connect	39	No connect	59	No connect	78		
R8	22										

34934C-001 D-Sub Connectors: Wiring for 8x64

NOTE

The D-Sub connector pin assignments for the 34934C-001 configuration block mirror those shown for the 34934A module. However—for safety reasons—the *D-Sub pin assignments for the 34934C-002 configuration block* **do not** mirror those for the 34934A module. Please consult the correct configuration sections for wiring to the D-Sub connectors.

Safety Interlock Continuity While wiring to the 34934C-002's D-Sub connectors, you *must* make the following connections—in addition to the 8x64 row and column connections—to provide for safety interlock continuity:

Short: Pin 59 to Pin 77 on Bank 1

Short: Pin 40 to Pin 61 on Bank 2

Configuring an 8x64 Matrix by Direct Wiring 34934A module D-Sub Connectors: 8x64 Pin Assignments

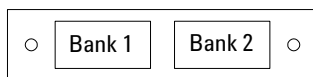

For orientation, the D-sub connector end of the module is facing you.

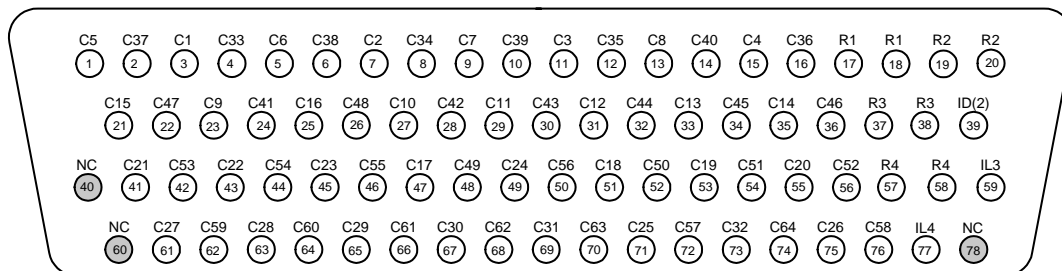

78-Pin D-Sub Male Connector

Bank 1

Description	Pin	Description	Pin	Description	Pin	Description	Pin	Description	Pin	Description	Pin
R1	17	C1	3	C17	47	C33	4	C49	48	No connect	40
R1	18	C2	7	C18	51	C34	8	C50	52	No connect	60
R2	19	C3	11	C19	53	C35	12	C51	54	No connect	78
R2	20	C4	15	C20	55	C36	16	C52	56		
R3	37	C5	1	C21	41	C37	2	C53	42		
R3	38	C6	5	C22	43	C38	6	C54	44		
R4	57	C7	9	C23	45	C39	10	C55	46		
R4	58	C8	13	C24	49	C40	14	C56	50		
		C9	23	C25	71	C41	24	C57	72		
ID2	39	C10	27	C26	75	C42	28	C58	76		
IL3	59	C11	29	C27	61	C43	30	C59	62		
IL4	77	C12	31	C28	63	C44	32	C60	64		
		C13	33	C29	65	C45	34	C61	66		
		C14	35	C30	67	C46	36	C62	68		
		C15	21	C31	69	C47	22	C63	70		
		C16	25	C32	73	C48	26	C64	74		

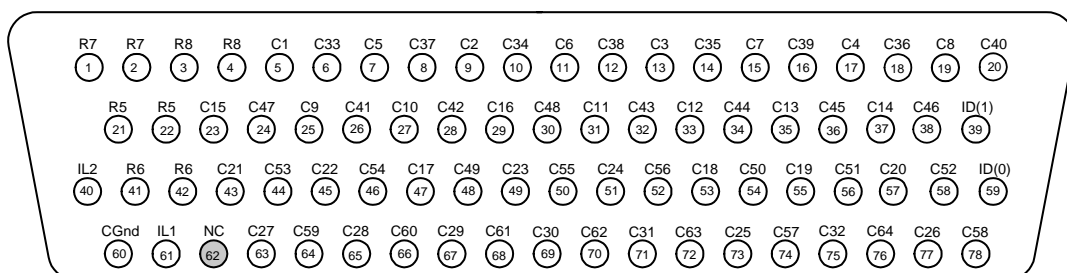

78-Pin D-Sub Male Connector

Bank 2

Description	Pin	Description	Pin	Description	Pin	Description	Pin	Description	Pin	Description	Pin
R5	21	C1	5	C17	47	C33	6	C49	48	No connect	62
R5	22	C2	9	C18	53	C34	10	C50	54		
R6	41	C3	13	C19	55	C35	14	C51	56		
R6	42	C4	17	C20	57	C36	18	C52	58		
R7	1	C5	7	C21	43	C37	8	C53	44		
R7	2	C6	11	C22	45	C38	12	C54	46		
R8	3	C7	15	C23	49	C39	16	C55	50		
R8	4	C8	19	C24	51	C40	20	C56	52		
		C9	25	C25	73	C41	26	C57	74		
ID0	59	C10	27	C26	77	C42	28	C58	78		
ID1	39	C11	31	C27	63	C43	32	C59	64		
IL1	61	C12	33	C28	65	C44	34	C60	66		
IL2	40	C13	35	C29	67	C45	36	C61	68		
		C14	37	C30	69	C46	38	C62	70		
		C15	23	C31	71	C47	24	C63	72		
		C16	29	C32	75	C48	30	C64	76		

34934A Module D-Sub Connectors: 8x64 Wiring

When wiring directly to the 34934A's D-Sub connectors, you *must* make the following connections—in addition to row and column connections—to configure the 8x64 matrix:

Module Configuration: The 72 connections listed below are required to create the 8x64 matrix.

To Create This Column #	Short This Pin on Bank 1...	...To This Pin on Bank 2	To Create This Column #	Short This Pin on Bank 1...	...To This Pin on Bank 2
C1	3	5	C33	4	6
C2	7	9	C34	8	10
C3	11	13	C35	12	14
C4	15	17	C36	16	18
C5	1	7	C37	2	8
C6	5	11	C38	6	12
C7	9	15	C39	10	16
C8	13	19	C40	14	20
C9	23	25	C41	24	26
C10	27	27	C42	28	28
C11	29	31	C43	30	32
C12	31	33	C44	32	34
C13	33	35	C45	34	36
C14	35	37	C46	36	38
C15	21	23	C47	22	24
C16	25	29	C48	26	30
C17	47	47	C49	48	48
C18	51	53	C50	52	54
C19	53	55	C51	54	56
C20	55	57	C52	56	58
C21	41	43	C53	42	44
C22	43	45	C54	44	46
C23	45	49	C55	46	50
C14	49	51	C56	50	52
C25	71	73	C57	72	74
C26	75	77	C58	76	78
C27	61	63	C59	62	64
C28	63	65	C60	64	66
C29	65	67	C61	66	68
C30	67	69	C62	68	70
C31	69	71	C63	70	72
C32	73	75	C64	74	76

To Create This Row #	Short This Pin on Bank 2...	...To This Pin on Bank 2	To Create This Row #	Short This Pin on Bank 1...	...To This Pin on Bank 1
R1	17	18	R5	21	22
R2	19	20	R6	41	42
R3	37	38	R7	1	2
R4	57	58	R8	3	4

Note that these connections require wires run *between* the two D-Sub connectors. You may make these connections near your test instrumentation or DUT, or near the D-Sub ends of your custom cabling.

Module ID: The open pins listed below allow the 34980A mainframe to recognize the 8x64 matrix configuration.

Ground: Pin 39 on Bank 1 (ID bit 2)

Ground: Pin 39 on Bank 2 (ID bit 1)

Ground: Pin 59 on Bank 2 (ID bit 0)

Safety Interlock Continuity: The connections listed below provide for safety interlock continuity.

Short: Pin 59 to Pin 77 on Bank 1

Short: Pin 40 to Pin 61 on Bank 2

NOTE

The D-Sub connector pin assignments for the 34934C-001 configuration block mirror those shown for the 34934A module. However—for safety reasons—the *D-Sub pin assignments for the 34934C-002 configuration block do not mirror those for the 34934A module*. Please consult the correct configuration sections for wiring to the D-Sub connectors.

NOTE

If you use the 34934C-002 Configuration Block—in conjunction with the 34934A module—to make wiring connections, the additional **Module Configuration** and **Module ID** connections are *not required*. Those connections are made within the hardware of the configuration block. You would need only make the **Safety Interlock Continuity** connections.

16x32 Matrix Configuration

To create a 16x32 matrix, you may connect your field wiring to the 34934A by three methods:

Terminal Block You can use terminal block 34934T-002. The terminal block connects to the 34934A's two D-Sub connectors; it provides 12 blocks of 12 screw terminals each, and a *16x32 removable overlay* (supplied with the 34934T-002) which provides guidance for field wiring the 16x32 matrices. Follow these sections in order to configure and wire the terminal block:

- “34934T-002 Terminal Block: 16x32 Layout” on page 133
- “34934T-002 Terminal Block: 16x32 Jumper Configuration” on page 135
- “34934T-002 Terminal Block: 16x32 Wiring” on page 137

Configuration Block You can use configuration block 34934C-001. Follow these sections in order to configure and wire the configuration block:

- “34934C-002 Configuration Block: Layout” on page 140
- “34934C-002 Configuration Block: 16x32 Jumper Configuration” on page 141
- “34934C-002 Configuration Block: Wiring” on page 147

NOTE

Use of the 34934C-002 precludes use of a piggy-backed 34934T-002 terminal block for field wiring connections; the combination is not mechanically reliable.

Direct Wiring You can wire directly to the module's D-Sub connectors using custom cabling. You will have to short specific pins on and between the D-Sub connectors to create the 16x32 configuration. Review *both* these sections *before* wiring to the module's D-Subs:

- “34934A D-Sub Connectors: 16x32 Pin Assignments” on page 151
- “34934A Module D-Sub Connectors: 16x32 Wiring” on page 152

Configuring a 16x32 Matrix using a Terminal Block

34934T-002 Terminal Block: 16x32 Layout

This terminal block with screw-type connections is labeled with the model number and the abbreviated module name. In addition, space is available on the label for you to write the slot number.

The *34980A Product Reference* CD (shipped with the module) contains a 34934T Wiring Log for you to document your wiring configuration for this module. You can open the wiring log file in Microsoft® Excel® or Adobe® Acrobat® format.

This terminal block's *16x32 removable overlay* shows the row and column terminals for the 16x32 matrix configuration:

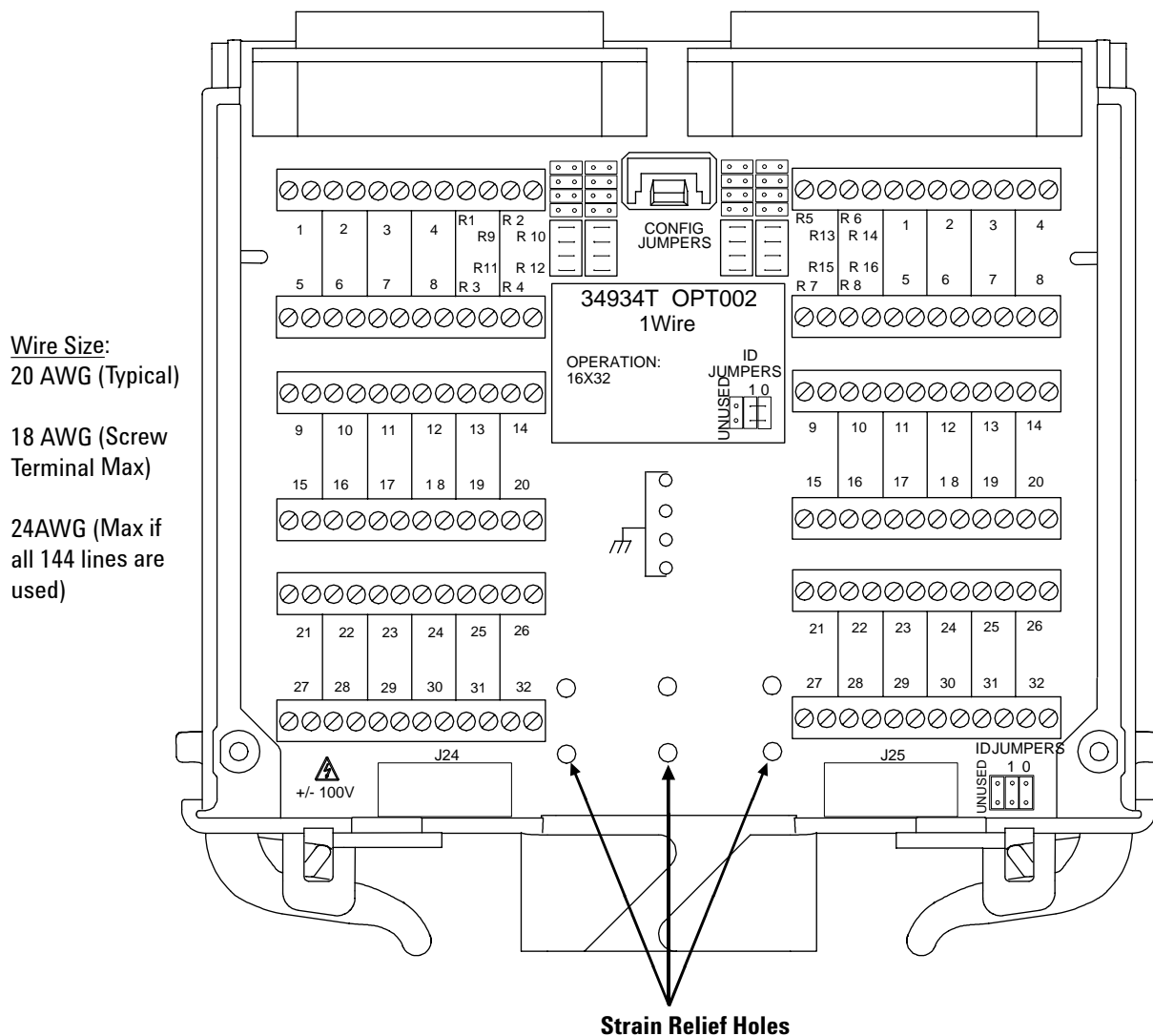

Note the six strain relief holes provided in the terminal block PCB. See the following page for instructions on providing wiring strain relief.

Terminal block strain relief

To reduce strain on the wiring at the terminals and maintain connection reliability, a strain relief feature has been incorporated into the terminal block design. Six holes have been placed near the lower edge of the circuit board, lined up with holes in the terminal block's bottom cover, as seen on “34934T-002 Terminal Block: 16x32 Layout” on page 133.

To use this feature:

- 1 Once all jumpers are installed and wiring is connected to the terminals, arrange the wires leading away from the terminal block in two bundles. This is easiest if the left bundle leads to the terminals on the left side of the block, and conversely for the right side.
- 2 Insert a cable tie (tie-wrap, zip-tie) down through each of the four outside holes in the PCB, continuing down through the holes in the terminal block's bottom cover.
- 3 Route these cable ties up through the center holes in the bottom cover and PCB.
- 4 Close and tighten the cable ties as required, and remove any excess so that it does not interfere with cover closure.

The completed bundles are shown below.

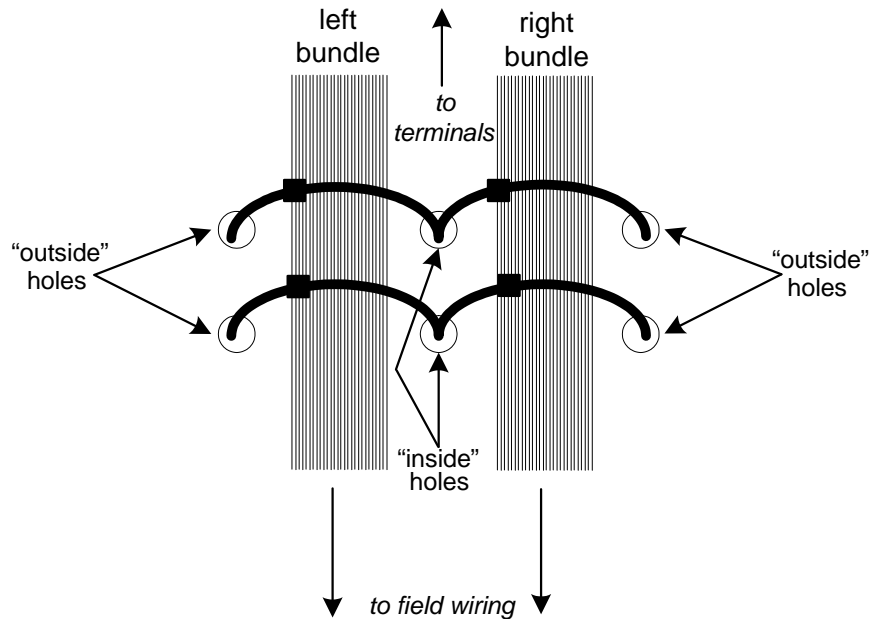

34934T-002 Terminal Block: 16x32 Jumper Configuration

This terminal block has three types of jumpers which must be connected to configure the 16x32 matrix (matrices):

- **CONFIG Jumpers:** place these 2-pin jumpers *identically on all four* 4x2 blocks of jumper pins located near the board's female D-Sub connectors, as shown.
- **ID Jumpers:** place these 2-pin jumpers on a 2x3 block of jumper pins on the lower right corner of the board, as shown.
- **Safety Interlock Continuity Jumpers:** place the supplied pre-wired terminators or equivalent custom wiring on the two 20-pin extension headers at the bottom of the terminal block, as shown.

Placing CONFIG Jumpers for 16x32 The CONFIG jumper area—shown below with jumpers removed—has an illustration below it (on the *16x32 removable overlay*) providing jumper placement guidance for 16x32 matrix configuration.

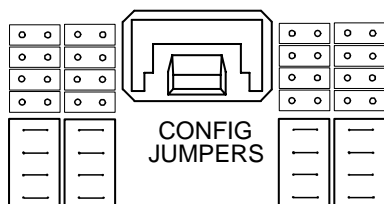

There are four 4x2 blocks of CONFIG JUMPER pins on either side of the board's center—you *must* set all four blocks identically.

- 1 Place sixteen horizontally positioned jumpers as shown below.

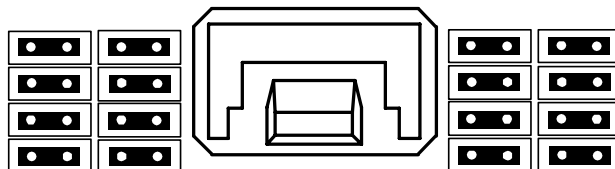

Placing ID Jumpers for 16x32 The ID jumpers allow the 34980A to recognize the 16x32 matrix configuration, upon mainframe bootup. Jumper placement guidance is provided (on the *16x32 removable overlay*) as shown below left; the ID jumper block is shown at right with jumpers removed.

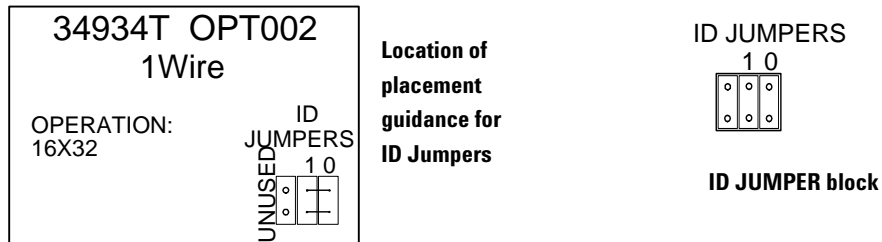

To set the correct ID code for 16x32, place two horizontally positioned jumpers as shown below.

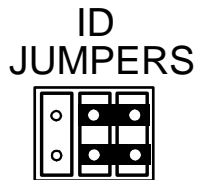

Placing Safety Interlock Continuity Jumpers for 16x32 At the bottom (end opposite the D-Sub connectors) of the terminal block are two 20-pin extension headers—marked J24 and J25 on the circuit board. These headers provide access to the module’s rows. Pins 19 and 20 on each header must be shorted to provide continuity for the module’s safety interlock function.

Two keyed 20-pin terminators are supplied for providing safety interlock continuity. Install the terminators securely in the headers, as shown below.

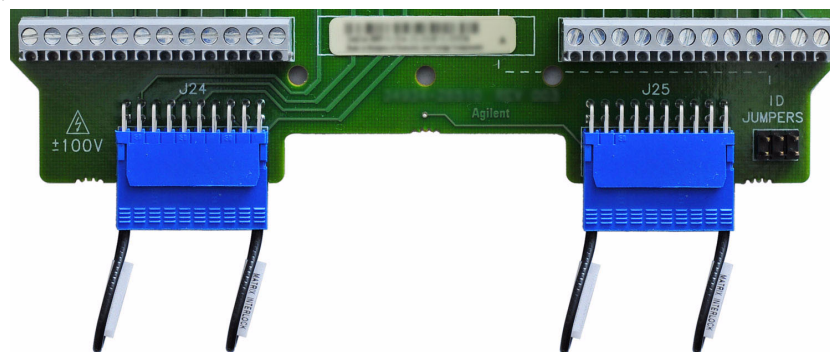

The supplied terminators incorporate both the shorting jumper for pins 19 and 20 and a jumper precluding connection to pins 1 and 2. Detailed pin diagrams for these terminators are provided on [page 96](#).

34934T-002 Terminal Block: 16x32 Wiring

Once the required jumpers have been placed for 16x32, you are ready to complete 16x32 wiring configuration; then make row and column connections to the terminal block.

Terminal block wire jumpers

You *must* provide a jumper on the terminal block between the left and right screw terminals for each of the 32 columns. This can be done—channel by channel—on either side of the terminal block, but not on both sides for any channel. An example of jumper placement is shown below.

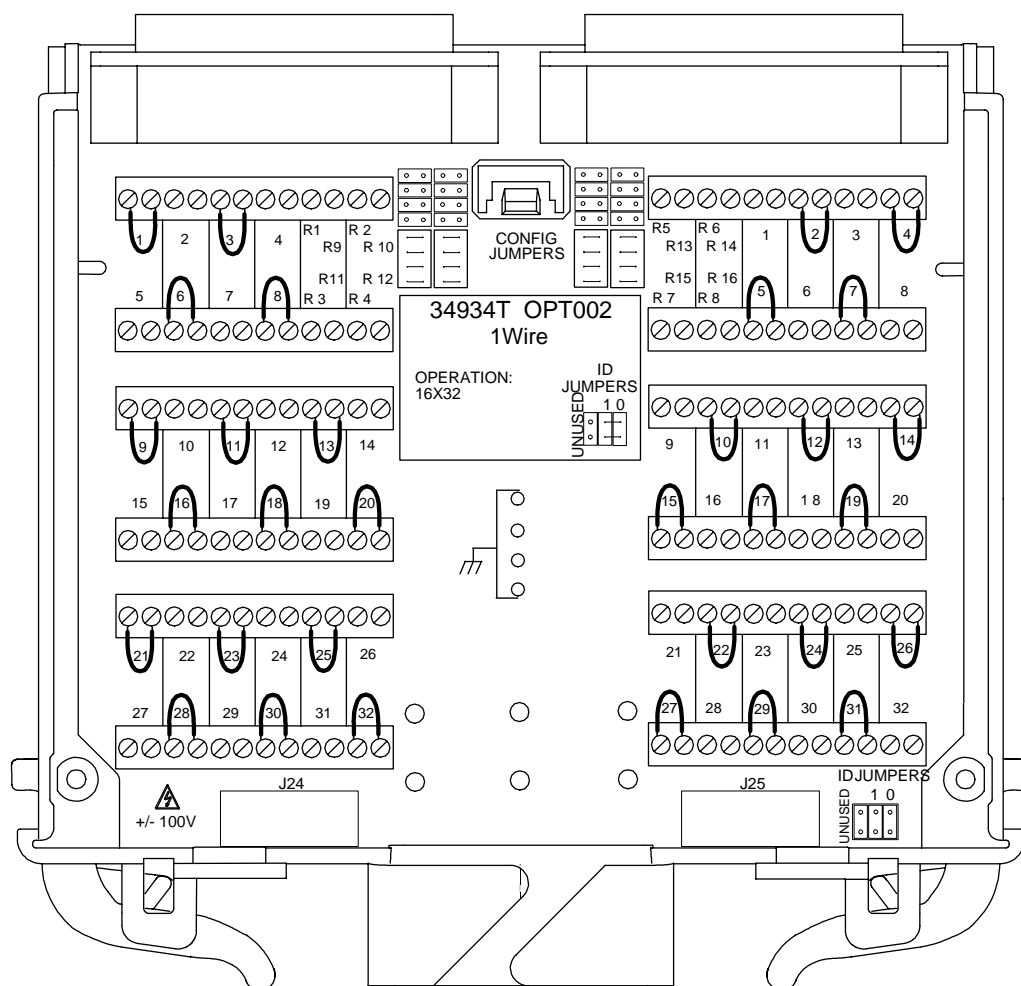

Once these jumpers are placed, you can make column connections to the column terminals which remain open.

Row and Column Wiring

You may connect to the module's rows and columns by wiring to the screw terminals marked C1 through C32 and R1 through R16 (H, L) on the silk-screen (see [“34934T-002 Terminal Block: 16x32 Layout”](#) on page 133). The combined weight of these wires can create significant strain on the wiring; to minimize this see [“34934T-002 Terminal Block: 8x64 Terminal Wiring Options”](#) on page 113.

However, you may prefer to use physically separate cabling for the row connections (e.g. if you connect your DUT to the columns and your measurement device(s) to the rows). The terminal block's extension headers J24 and J25 provide access to the rows; you can make row connections to the central 16 terminals (pins 3-18) on the supplied terminators you installed in [“Placing Safety Interlock Continuity Jumpers for 16x32”](#) on page 136.

Below is an illustration of the possible locations for making row signal connections to the 34934T-002:

You can connect row signals to the screw terminals here...

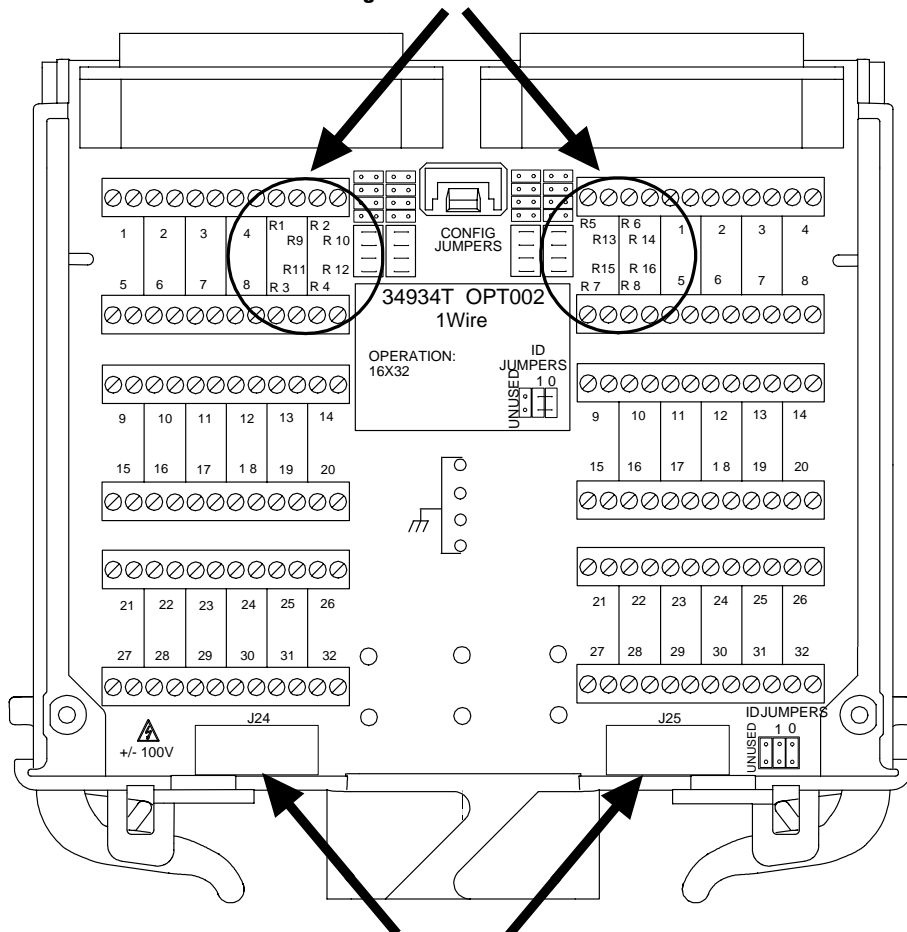

...or to the central 16 pins of extension headers J24 or J25 here.

The following subsection outlines how to make row connections to extension headers J24 or J25.

Extension Header (Row Signal) Wiring for 16x32 The position of extension headers J24 and J25 are marked on the 34934T-002’s silk-screen. Oriented with the terminal side of the board up, the pin numbers for these headers are shown below.

Extension Headers J24 and J25

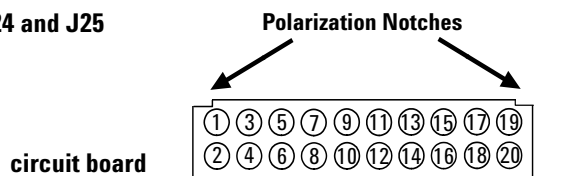

The supplied 20-pin terminators are identical, but the pin assignments for 16x32 are not (rows 1-8 are on J24; rows 9-16 are on J25). The terminal numbers—corresponding to the headers—are shown below. *Pay careful attention to the indexing keys on the connectors, to correctly identify terminal #1.*

20-Pin Terminators for J24 and J25

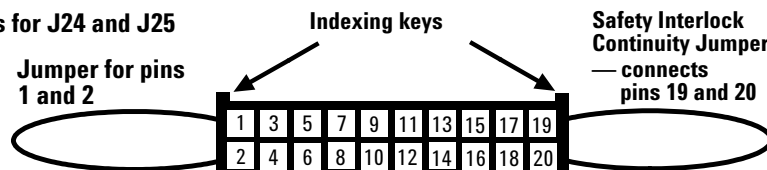

You must fabricate custom cabling to make row signal connections to the central 16 pins (3-18) of these headers, using the pin assignments below. The supplied blue terminators accommodate 22 AWG coated wire, fitted to “crimp-to-wire” contacts with latch tabs (FCI part #76357-301LF or equivalent).

34934T-002: Extension Header Pin Assignments for 16x32

Header J24				Header J25			
Description	Pin	Description	Pin	Description	Pin	Description	Pin
No Connect	1	No Connect	2	No Connect	1	No Connect	2
R1	3	R1	4	R5	3	R5	4
R2	7	R2	8	R6	7	R6	8
R3	11	R3	12	R7	11	R7	12
R4	15	R4	16	R8	15	R8	16
R9	5	R9	6	R13	5	R13	6
R10	9	R10	10	R14	9	R14	10
R11	13	R11	14	R15	13	R15	14
R12	17	R12	18	R16	17	R16	18
IL1	19	IL2	20	IL3	19	IL4	20

Note that each row signal (R1 through R16) is routed out on two pins on the extension headers. You can make row signal connections to either row (upper, lower) of the connector.

If you are going to create an expanded-row matrix using multiple modules and terminal blocks, plan your wiring placement for each terminal block carefully, to allow for a daisy-chain interconnection between terminal blocks—in addition to any row wiring you may connect to the expansion headers. This interconnection is illustrated in “[Arranging Multiple 34934A Modules with Terminal Blocks](#)” on page 158.

Configuring a 16x32 Matrix using a Configuration Block

34934C-002 Configuration Block: Layout

This configuration block is labeled with the model number and the abbreviated module name.

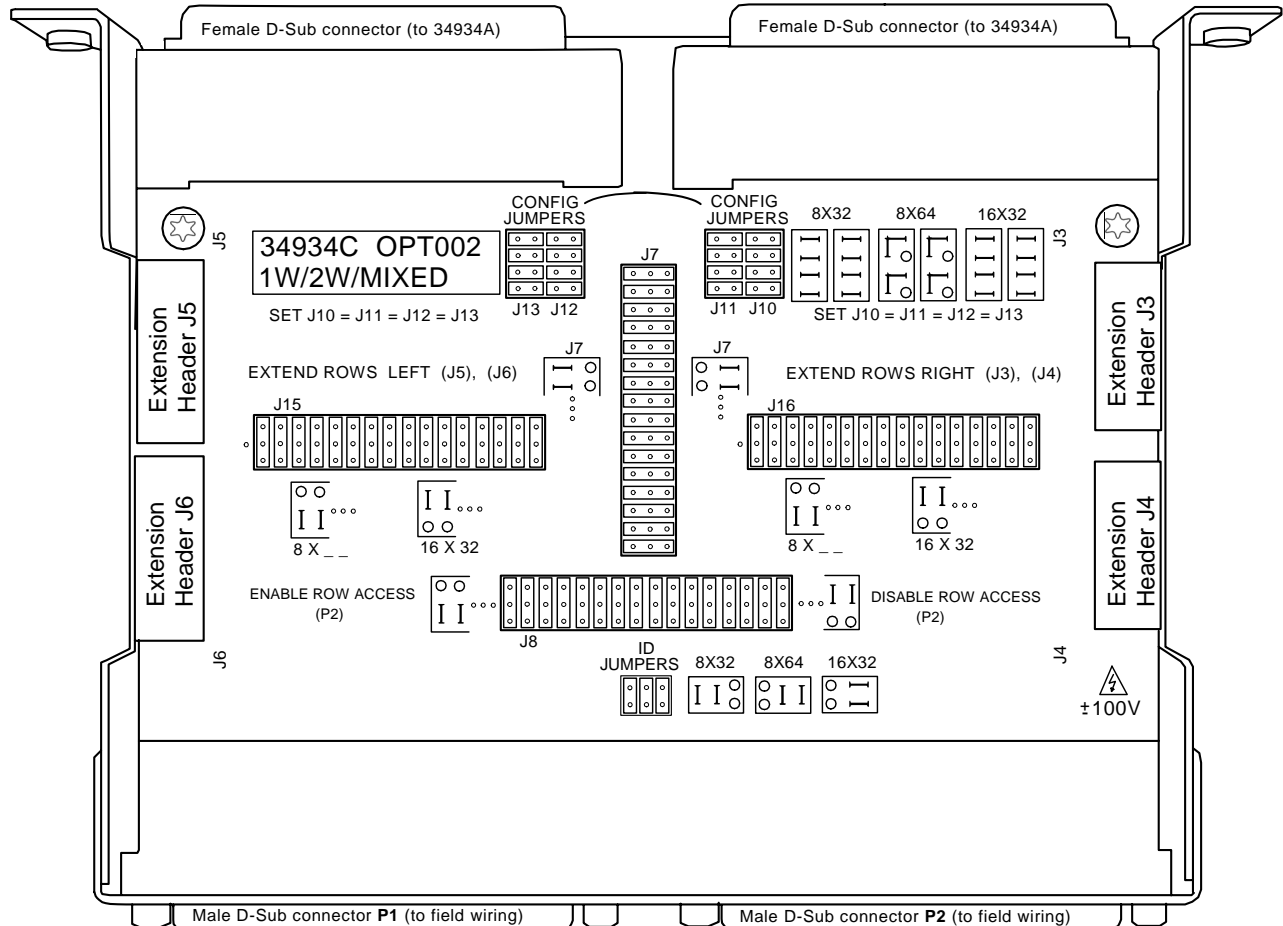

Note five types of on-board jumpers you'll have to set to configure this board; some will be familiar from the configuration descriptions of the *terminal blocks*, but some are new. Instructions for setting these are provided in “[34934C-002 Configuration Block: 16x32 Jumper Configuration](#)” on page 141.

- ID Jumpers
- CONFIG Jumpers (J10, J11, J12 and J13)
- Row Extension Jumpers (J7)
- Row Access Jumpers (J8)
- Row Setting Jumpers (J15 and J16)

Also note the four extension headers (J3, J4, J5 and J6). Instructions for wiring to these are provided in “[34934C-002 Configuration Block: Wiring](#)” on page 147.

34934C-002 Configuration Block: 16x32 Jumper Configuration

The configuration block has five types of jumpers which must be connected to configure it for use in an expanded 4-row matrix. In this section, you will place:

- **ID Jumpers:** place these 2-pin jumpers on a 2x3 block of jumper pins near the bottom center of the board. See [“Placing ID Jumpers on the 34934C-002 Configuration Block for 16x32”](#) on page 142.
- **CONFIG Jumpers:** place these 2-pin jumpers *identically on all four* 4x2 blocks of jumper pins located near the board’s female D-Sub connectors. See [“Placing CONFIG Jumpers on the 34934C-002 Configuration Block for 16x32”](#) on page 142.
- **Row Extension Jumpers:** place these 16-pin jumpers on a 16x3 block (J7) of jumper pins at the board’s center. See [“Placing Row Extension Jumpers on the 34934C-002 Configuration Block”](#) on page 143.
- **Row Access Jumpers:** place these 16-pin jumpers on a 3x16 block of jumper pins located just above the ID Jumpers. See [“Placing Row Access Jumpers on the 34934C-002 Configuration Block”](#) on page 144.
- **Safety Interlock Continuity Jumpers:** place the supplied pre-wired terminators on the four 20-pin extension headers at the sides of the configuration block. See [“Placing Safety Interlock Continuity Jumpers on the 34934C-002 Configuration Block”](#) on page 146.

Placing ID Jumpers on the 34934C-002 Configuration Block for 16x32 The ID jumpers allow the 34980A to recognize the base matrix configuration used by the 34934C-002, upon mainframe bootup. The ID jumpers are placed in a 2x3 jumper block, located below jumper block J8. Jumper placement guidance is provided on the configuration block’s silk-screen, to the right of the jumpers:

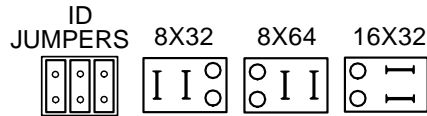

To set the correct ID code for 16x32, place two horizontally positioned jumpers as shown below.

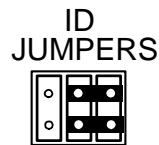

Placing CONFIG Jumpers on the 34934C-002 Configuration Block for 16x32 The CONFIG jumper area—shown below with jumpers removed—has an illustration to its right providing jumper placement guidance for the 8x32, 8x64 and 16x32 base matrix configurations.

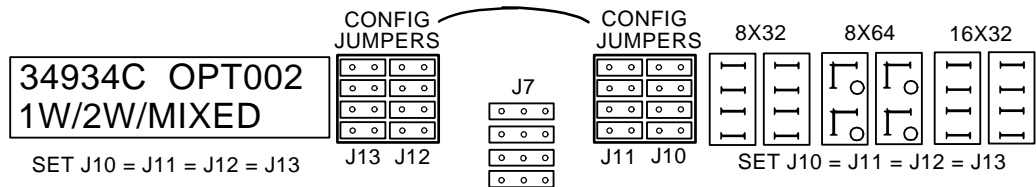

To set the CONFIG jumpers for 16x32, place 16 horizontally positioned jumpers as shown below.

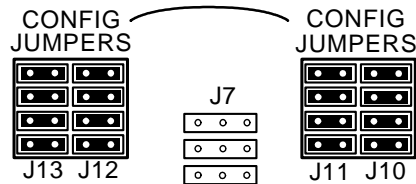

Placing Row Extension Jumpers on the 34934C-002 Configuration Block The jumpers in 16x3 jumper block J7 (at board center) determine if row connections can be made from the left or right side of the board (i.e. they “extend” the row signal connection points out to *only one* of the two pairs of blue 20-pin connectors at the sides of the configuration block).

Note that “row connections” at minimum include the connections between modules in the matrix, but may also include your access from field wiring to the matrix rows.

Setting these jumpers provides you the flexibility to plan how to route your custom cabling, depending on slot placement of the individual 34934A modules and their corresponding 34934C-002 blocks.

The following illustration shows the jumper block J7, along with the relevant guidance provided on the board’s silk-screen for jumper placement:

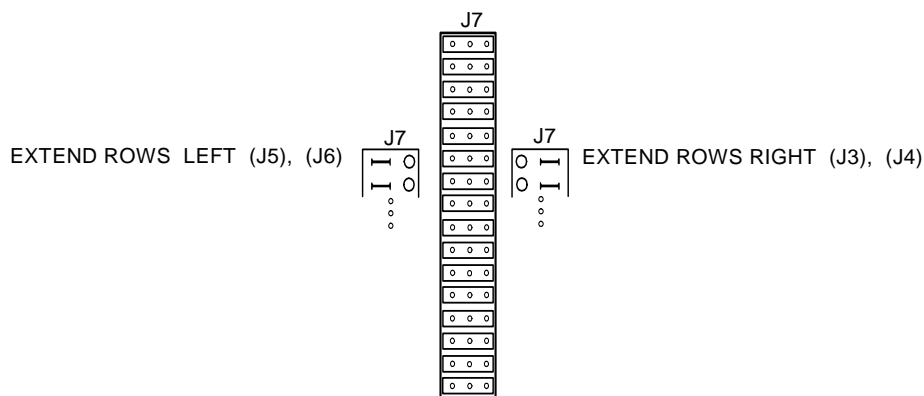

If you plan to extend rows *left*, to J5 and J6, place two 2x8 jumpers as shown at right.

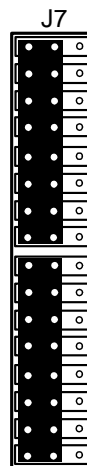

If you plan to extend rows *right*, to J3 and J4, place two 2x8 jumpers as shown at right.

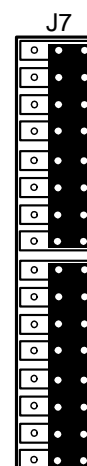

Placing Row Access Jumpers on the 34934C-002 Configuration Block The jumpers in 3x16 jumper block J8 (at lower board center) determine if row connections can be made from the male D-Sub connector P2 (i.e. they “enable” the row signal connection points at this D-sub).

These “row connections” are the traditional access points from field wiring to the matrix rows. In practice, your arrangement of test instrumentation and DUT test points will determine if you wish to make row connections at the D-sub, at the blue 20-pin extension connectors, or both.

Setting these jumpers provides you the flexibility to plan how to route your custom cabling.

The following illustration shows the jumper block J8, along with the relevant guidance provided on the board’s silk-screen for jumper placement.

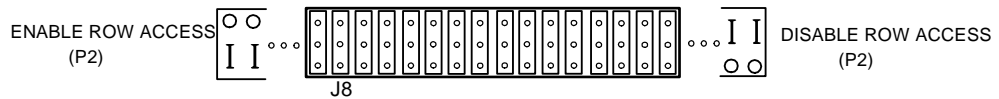

If you plan to connect row signals to D-sub connector P2, place two 2x8 jumpers on block J8, as shown below.

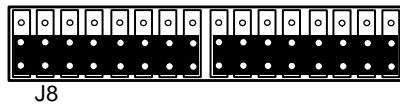

If you do not need to connect row signals to D-sub connector P2, place two 2x8 jumpers on block J8, as shown below.

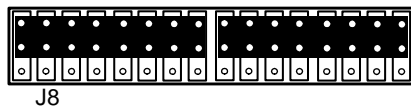

By not routing signals to the D-sub connectors, you avoid adding their extra capacitance.

Placing Row Setting Jumpers on the 34934C-002 Configuration Block

The jumpers in 3x16 jumper blocks J 15 and J16 (left and right of lower board center) set the row depth (i.e. 8-rows or 16-rows) for the expanded matrix. In conjunction with the CONFIG jumpers, these jumpers set the matrix configuration.

The following illustration shows jumper blocks J15 and J16, along with the relevant guidance provided on the board's silk-screen for jumper placement.

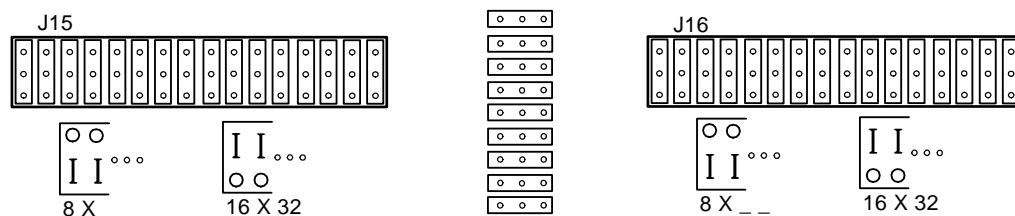

For a base configuration of 16x32, place two 2x8 jumpers *on each of* blocks J15 and J16, as shown below.



Placing Safety Interlock Continuity Jumpers on the 34934C-002 Configuration Block

Block At each side of the configuration block are a pair of 20-pin extension headers. On the right side are labeled J3 and J4; on the left side are J5 and J6. In all cases, pins 19 and 20 are the safety interlock pins.

These headers provide for row extension and row signal access, depending on the placement of the jumpers in J7. You must have set the jumpers to extend rows either to the left or right side of the configuration block (see [“Placing Row Extension Jumpers on the 34934C-002 Configuration Block”](#) on page 143).

To provide continuity for the module’s safety interlock function, pins 19 and 20 on *both* extension headers on the selected side (left or right) must be shorted.

- For each of these headers, install one of the supplied keyed 20-pin terminators securely in that header, as shown below.

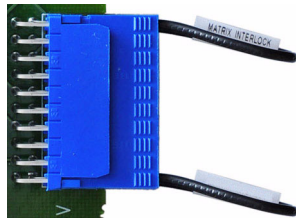

The supplied terminators incorporate both the shorting jumper for pins 19 and 20 and a jumper precluding connection to pins 1 and 2.

- The extension headers on the opposite side of the 34934C-002 do not require a safety interlock terminator; these will be hidden by the configuration block’s cover.

34934C-002 Configuration Block: Wiring

The next two subsections outline options for making row and column wiring connections to the configuration block.

Extension Header (Row Signal) Wiring to the 34934C-002

Below is an illustration of the possible locations for making row signal connections to the 34934T-002

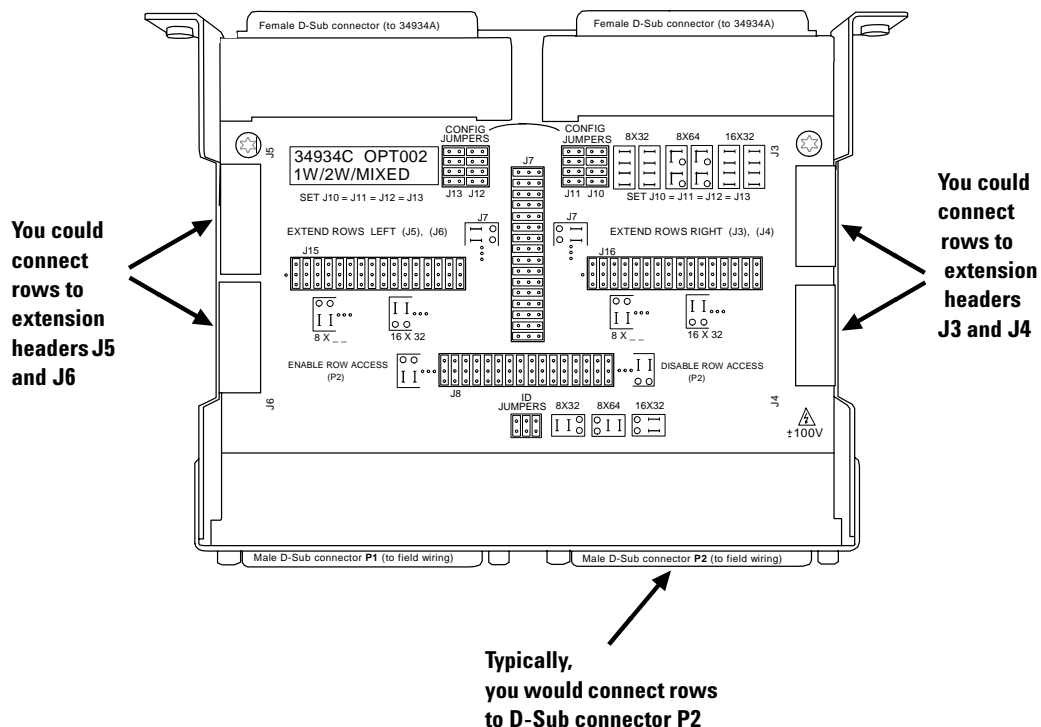

Typically, you could make both row and column connections to each module by fabricating custom cabling terminating in female D-Sub connectors. These attach to the configuration block's male D-Sub connectors P1 and P2. For 16x32, all rows connect to P2.

Alternately, you may choose to connect only columns (typically test points on your DUT) to the D-Subs. There may be physical or electrical advantages in making your *row* connections (typically measurement devices) to the configuration block's blue extension connectors J3, J4, J5 and J6. To provide this flexibility, two extension headers are provided on each side of the configuration block.

You must have set the jumpers (in "Placing Row Extension Jumpers on the 34934C-002 Configuration Block" on page 143) to extend rows to two of the four headers. We'll call these the "live" headers.

In “Placing Safety Interlock Continuity Jumpers on the 34934C-002 Configuration Block” on page 146, you will have installed the supplied blue terminators in the live headers on the configuration block.

You can now make row connections to these headers, by utilizing the central 16 pins (3-18) on the snap-in terminators. The extension header’s supplied terminator is shown below. Pay careful attention to the polarizing notches for identification of pin 1:

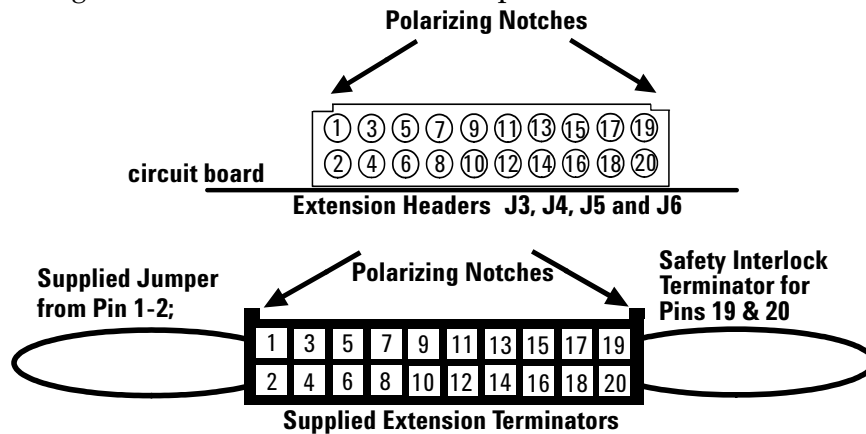

You must fabricate custom cabling to make row signal connections to the central 16 pins (3-18) of these headers, using the pin assignments below. The supplied blue terminators accommodate 22 AWG coated wire, fitted to “crimp-to-wire” contacts with latch tabs (FCI part #76357-301LF or equivalent).

34934C-002: Extension Header Pin Assignments for 16x32

Headers J4, J5				Headers J3, J6			
Description	Pin	Description	Pin	Description	Pin	Description	Pin
No connect	1	No connect	2	No connect	1	No connect	2
R1	3	R1	4	R5	3	R5	4
R9	5	R9	6	R13	5	R13	6
R2	7	R2	8	R6	7	R6	8
R10	9	R10	10	R14	9	R14	10
R3	11	R3	12	R7	11	R7	12
R11	13	R11	14	R15	13	R15	14
R4	15	R4	16	R8	15	R8	16
R12	17	R12	18	R16	17	R16	18
IL1	19	IL2	20	IL3	19	IL4	20

Note that each row signal (R1 through R16) is routed out on two pins on the extension headers. You can make row signal connections to either row (upper, lower) of the connector.

If you are going to create an expanded-row matrix using multiple modules and configuration blocks, plan your wiring placement for each configuration block carefully, to allow for a daisy-chain interconnection between configuration blocks—in addition to any row wiring you may connect to the expansion headers. This interconnection is illustrated in “Arranging Multiple 34934A Modules with Configuration Blocks” on page 160.

34934C-002 D-Sub Connectors: Pin Assignments for 16x32 (base configuration)

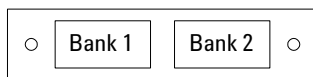

For orientation, the male D-sub connector end of the configuration block is facing you.

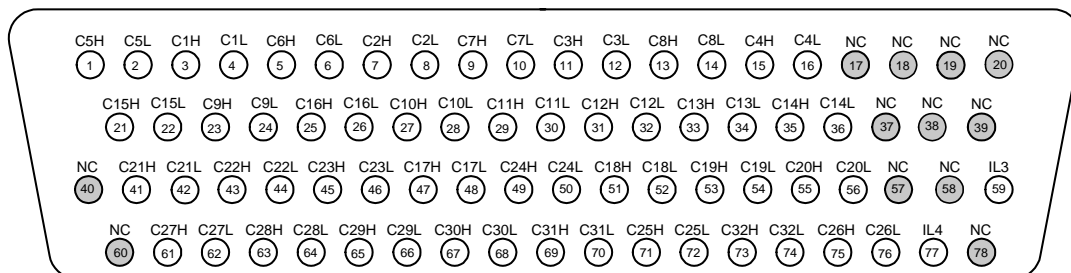

78-Pin D-Sub Male Connector

Bank 1 (P1)

Description	Pin	Description	Pin	Description	Pin	Description	Pin	Description	Pin	Description	Pin
IL3	59	C1	3	C9	23	C17	47	C25	71	No connect	17
IL4	77	C1	4	C9L	24	C17	48	C25	72	No connect	18
		C2	7	C10	27	C18	51	C26	75	No connect	19
		C2	8	C10	28	C18	52	C26	76	No connect	20
		C3	11	C11	29	C19	53	C27	61	No connect	37
		C3	12	C11	30	C19	54	C27	62	No connect	38
		C4	15	C12	31	C20	55	C28	63	No connect	39
		C4	16	C12	32	C20	56	C28	64	No connect	40
		C5	1	C13	33	C21	41	C29	65	No connect	57
		C5	2	C13	34	C21	42	C29	66	No connect	58
		C6	5	C14	35	C22	43	C30	67	No connect	60
		C6	6	C14	36	C22	44	C30	68	No connect	78
		C7	9	C15	21	C23	45	C31	69		
		C7	10	C15	22	C23	46	C31	70		
		C8	13	C16	25	C24	49	C32	73		
		C8	14	C16	26	C24	50	C32	74		

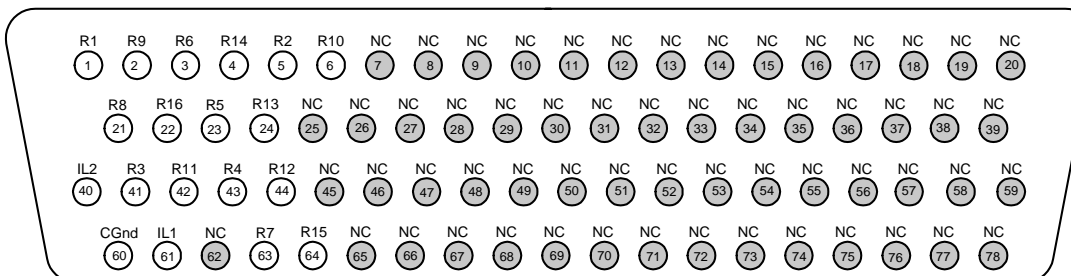

78-Pin D-Sub Male Connector

Bank 2 (P2)

Description	Pin	Description	Pin	Description	Pin	Description	Pin	Description	Pin	Description	Pin
R1	1	No connect	7	No connect	25	No connect	45	No connect	62	IL1	61
R2	5	No connect	8	No connect	26	No connect	46	No connect	65	IL2	40
R3	41	No connect	9	No connect	27	No connect	47	No connect	66	Com Gnd	60
R4	43	No connect	10	No connect	28	No connect	48	No connect	67		
R5	23	No connect	11	No connect	29	No connect	49	No connect	68		
R6	3	No connect	12	No connect	30	No connect	50	No connect	69		
R7	63	No connect	13	No connect	31	No connect	51	No connect	70		
R8	21	No connect	14	No connect	32	No connect	52	No connect	71		
R9	2	No connect	15	No connect	33	No connect	53	No connect	72		
R10	6	No connect	16	No connect	34	No connect	54	No connect	73		
R11	42	No connect	17	No connect	35	No connect	55	No connect	74		
R12	44	No connect	18	No connect	36	No connect	56	No connect	75		
R13	24	No connect	19	No connect	37	No connect	57	No connect	76		
R14	4	No connect	20	No connect	38	No connect	58	No connect	77		
R15	64			No connect	39	No connect	59	No connect	78		
R16	22										

34934C-001 D-Sub Connectors: Wiring for 16x32

NOTE

The D-Sub connector pin assignments for the 34934C-001 configuration block mirror those shown for the 34934A module. However—for safety reasons—the *D-Sub pin assignments for the 34934C-002 configuration block* **do not** mirror those for the 34934A module. Please consult the correct configuration sections for wiring to the D-Sub connectors.

Safety Interlock Continuity While wiring to the 34934C-002's D-Sub connectors, you *must* make the following connections—in addition to the 16x32 row and column connections—to provide for safety interlock continuity:

Short: Pin 59 to Pin 77 on Bank 1

Short: Pin 40 to Pin 61 on Bank 2

Configuring a 16x32 Matrix by Direct Wiring

34934A D-Sub Connectors: 16x32 Pin Assignments

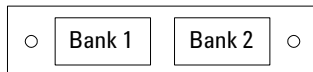

For orientation, the D-sub connector end of the module is facing you.

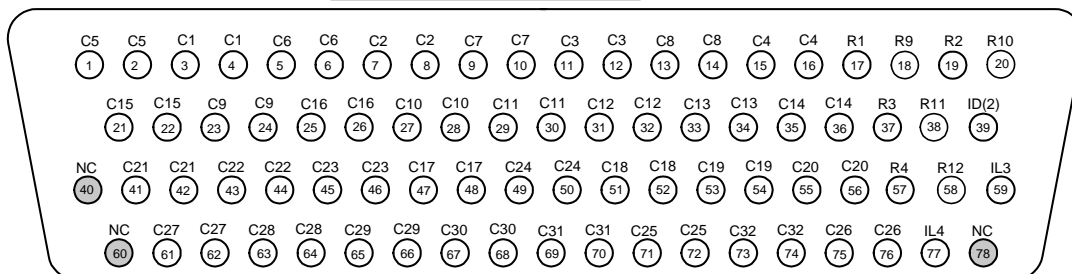

78-Pin D-Sub Male Connector
Bank 1

Description	Pin	Description	Pin	Description	Pin	Description	Pin	Description	Pin	Description	Pin
R1	17	C1	3	C9	23	C17	47	C25	71	No connect	40
R2	19	C1	4	C9	24	C17	48	C25	72	No connect	60
R3	37	C2	7	C10	27	C18	51	C26	75	No connect	78
R4	57	C2	8	C10	28	C18	52	C26	76		
		C3	11	C11	29	C19	53	C27	61	ID2	39
R9	18	C3	12	C11	30	C19	54	C27	62	IL3	59
R10	20	C4	15	C12	31	C20	55	C28	63	IL4	77
R11	38	C4	16	C12	32	C20	56	C28	64		
R12	58	C5	1	C13	33	C21	41	C29	65		
		C5	2	C13	34	C21	42	C29	66		
		C6	5	C14	35	C22	43	C30	67		
		C6	6	C14	36	C22	44	C30	68		
		C7	9	C15	21	C23	45	C31	69		
		C7	10	C15	22	C23	46	C31	70		
		C8	13	C16	25	C24	49	C32	73		
		C8	14	C16	26	C24	50	C32	74		

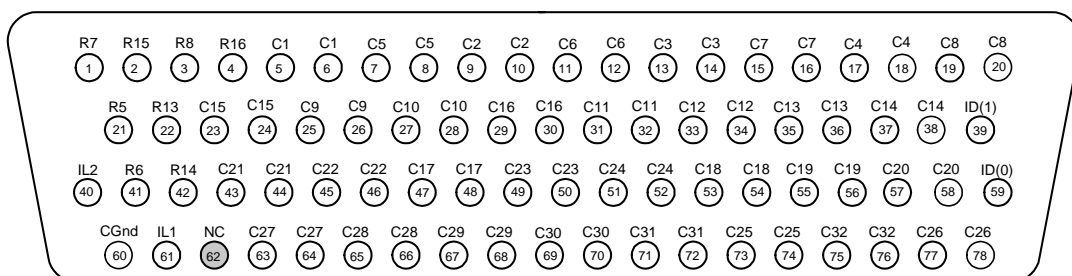

78-Pin D-Sub Male Connector
Bank 2

Description	Pin	Description	Pin	Description	Pin	Description	Pin	Description	Pin	Description	Pin
R5	21	C1	5	C9	25	C17	47	C25	73	No connect	62
R6	41	C1	6	C9	26	C17	48	C25	74		
R7	1	C2	9	C10	27	C18	53	C26	77	ID(0)	59
R8	3	C2	10	C10	28	C18	54	C26	78	ID(1)	39
		C3	13	C11	31	C19	55	C27	63	IL1	61
R13	22	C3	14	C11	32	C19	56	C27	64	IL2	40
R14	42	C4	17	C12	33	C20	57	C28	65		
R15	2	C4	18	C12	34	C20	58	C28	66		
R16	4	C5	7	C13	35	C21	43	C29	67		
		C5	8	C13	36	C21	44	C29	68		
		C6	11	C14	37	C22	45	C30	69		
		C6	12	C14	38	C22	46	C30	70		
		C7	15	C15	23	C23	49	C31	71		
		C7	16	C15	24	C23	50	C31	72		
		C8	19	C16	29	C24	51	C32	75		
		C8	20	C16	30	C24	52	C32	76		

34934A Module D-Sub Connectors: 16x32 Wiring

When wiring directly to the 34934A's D-Sub connectors, you *must* make the following connections—in addition to row and column connections—to configure the 16x32 matrix:

Module Configuration: The 96 connections listed in the two tables below (64 here; 32 in the table on the following page) are required to create the 16x32 matrix.

In the first table, note the **AND** indicating that you must short all connections shown. In the second table, note the **OR** indicating that for each line in the table, you must short one set of pins or the other, but not both.

To Create This Column #	Short This Pin on Bank 1...	...To This Pin on Bank 2	AND...	Short This Pin on Bank 1...	...To This Pin on Bank 2
C1	3	5		4	6
C2	7	9		8	10
C3	11	13		12	14
C4	15	17		16	18
C5	1	7		2	8
C6	5	11		6	12
C7	9	15		10	16
C8	13	19		14	20
C9	23	25		24	26
C10	27	27		28	28
C11	29	31		30	32
C12	31	33		32	34
C13	33	35		34	36
C14	35	37		36	38
C15	21	23		22	24
C16	25	29		26	30
C17	47	47		48	48
C18	51	53		52	54
C19	53	55		54	56
C20	55	57		56	58
C21	41	43		42	44
C22	43	45		44	46
C23	45	49		46	50
C14	49	51		50	52
C25	71	73		72	74
C26	75	77		76	78
C27	61	63		62	64
C28	63	65		64	66
C29	65	67		66	68
C30	67	69		68	70
C31	69	71		70	72
C32	73	75		74	76

To Create This Column #	Short This Pin on Bank 1...	...To This Pin on Bank 1	OR...	Short This Pin on Bank 2...	...To This Pin on Bank 2
C1	3	4		5	6
C2	7	8		9	10
C3	11	12		13	14
C4	15	16		17	18
C5	1	2		7	8
C6	5	6		11	12
C7	9	10		15	16
C8	13	14		19	20
C9	23	24		25	26
C10	27	28		27	28
C11	29	30		31	32
C12	31	32		33	34
C13	33	34		35	36
C14	35	36		37	38
C15	21	22		23	24
C16	25	26		29	30
C17	47	48		47	48
C18	51	52		53	54
C19	53	54		55	56
C20	55	56		57	58
C21	41	42		43	44
C22	43	44		45	46
C23	45	46		49	50
C24	49	50		51	52
C25	71	72		73	74
C26	75	76		77	78
C27	61	62		63	64
C28	63	64		65	66
C29	65	66		67	68
C30	67	68		69	70
C31	69	70		71	72
C32	73	74		75	76

Module ID: The open pins listed below allow the 34980A mainframe to recognize the 16x32 matrix configuration.

Ground: Pin 39 on Bank 1 (ID bit 2)
 Leave Open: Pin 39 on Bank 2 (ID bit 1)
 Leave Open: Pin 59 on Bank 2 (ID bit 0)

Safety Interlock Continuity: The connections listed below provide for safety interlock continuity.

Short: Pin 59 to Pin 77 on Bank 1
 Short: Pin 40 to Pin 61 on Bank 2

NOTE

If you use the 34934C-002 Configuration Block—in conjunction with the 34934A module—to make wiring connections, the additional **Module Configuration** and **Module ID** connections are *not required*. Those connections are made within the hardware of the configuration block. You would need only make the **Safety Interlock Continuity** connections.

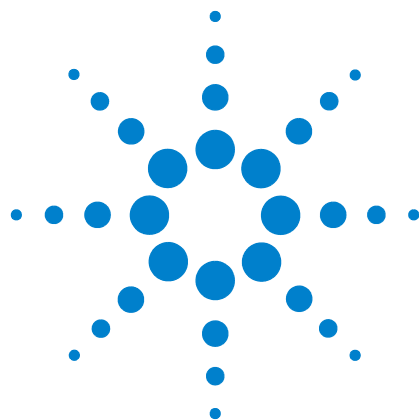

3

Expanded-Row Matrix Configuration

This chapter provides complete instructions for you to combine multiple *configured* 34934A modules to create large matrices.

Linking Multiple 34934A Matrix Modules [156](#)

Physical Arrangement of Multiple 34934A Modules in a 34980A Mainframe [157](#)

Arranging Multiple 34934A Modules with Terminal Blocks [158](#)

Arranging Multiple 34934A Modules with Configuration Blocks [160](#)

Creating Expanded-Row Matrices Using Terminal Blocks [162](#)

Interconnecting Terminal Blocks [163](#)

Creating Expanded-Row Matrices Using Configuration Blocks [164](#)

Interconnecting Configuration Blocks [165](#)



Linking Multiple 34934A Matrix Modules

You can combine up to eight modules to design your own large matrices. From a programming standpoint, each matrix module operates as an independent module regardless of the external connections. When linking modules, the channel numbering scheme for each module remains the same as for single modules.

The maximum row width (in columns) you can create with a single 34934A module is 128 for four rows, 64 for eight rows or 32 for 16 rows. Using multiple modules in the same 34980A mainframe—electrically linked using external cabling—you can create the following *expanded-row matrix* configurations:

Base Config	Number of Linked 34934A Modules Used in an Expanded-row Matrix						
	2	3	4	5	6	7	8
4x128	4x256	4x384	4x512	4x640	4x768	4x896	4x1024
8x64	8x128	8x192	8x256	8x320	8x384	8x448	8x512
16x32	16x64	16x96	16x128	16x160	16x192	16x224	16x256

Both the terminal blocks and configuration blocks provide a convenient means to link multiple 34934A modules, so that the resulting expanded-row structure can be treated as a single matrix.

Four-Row Matrices: Order a terminal block 34934T-001 (Option 001) or configuration block 34934C-001 (Option 001) for each 34934A module used in an expanded row matrix whose base configuration is *four rows*.

Eight-Row or Sixteen-Row Matrices: Order a terminal block 34934T-002 (Option 002) or configuration block 34934C-002 (Option 002) for each 34934A module used in an expanded row matrix whose base configuration is *eight or sixteen rows*.

Each terminal block or configuration block must be configured and wired individually, as if a stand-alone base matrix; complete instructions are in [Chapter 2](#), “Base Matrix Configuration”. *All blocks in an expanded row matrix must have their ID and CONFIG jumpers set identically.*

Once individually configured, you will create the large matrix (expand the rows) by linking the expansion headers on each block in a daisy-chain. You may then make row connections to that matrix at any open row on the appropriate header(s).

Physical Arrangement of Multiple 34934A Modules in a 34980A Mainframe

You can employ anywhere from two to eight module in a single 34980A mainframe to create an expanded matrix. This will depend on slot availability and your needs.

If using Terminal Blocks The terminal blocks must be linked (“daisy-chained” in the case of more than two modules) with module interconnections extending from the expansion headers at the rear of the terminal blocks.

If using Configuration Blocks The configuration blocks must be linked (“daisy-chained” in the case of more than two modules) with module interconnections extending from the expansion headers at the sides of the configuration blocks.

For flexibility, you can make these connections from either the right or left side of each configuration block.

In either case Plan carefully to provide adequate physical room to make all needed connections and allow for insertion/removal of other modules.

Some terminal blocks for other 34980A modules are shorter than those for the 34934A; if placed side-by-side in the mainframe, the 34934A may preclude independent removal of the shorter module. Therefore, if you need to attach or remove a shorter terminal block—adjacent to a 34934A with attached 34934T—the 34934T will need to be removed first.

Arranging Multiple 34934A Modules with Terminal Blocks

The illustrations below show just a few of the possible physical installations of multiple 34934A-34934T pairs in a 34980A mainframe.

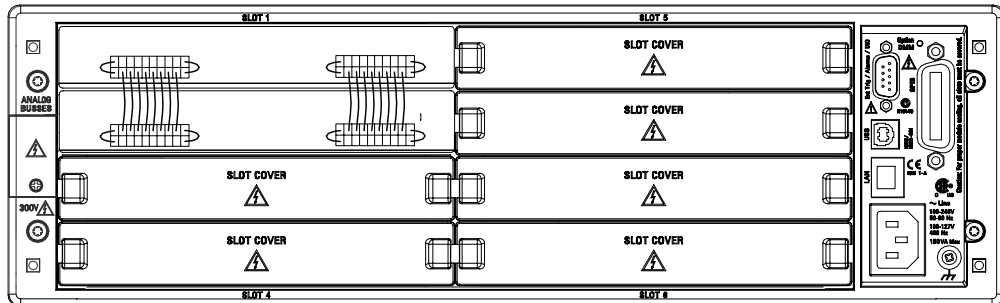

Two 34934A modules (with attached terminal blocks) connected in an extended-row configuration.
 Example: base configuration for each is 4x128; resulting expanded-row matrix is 4x256.

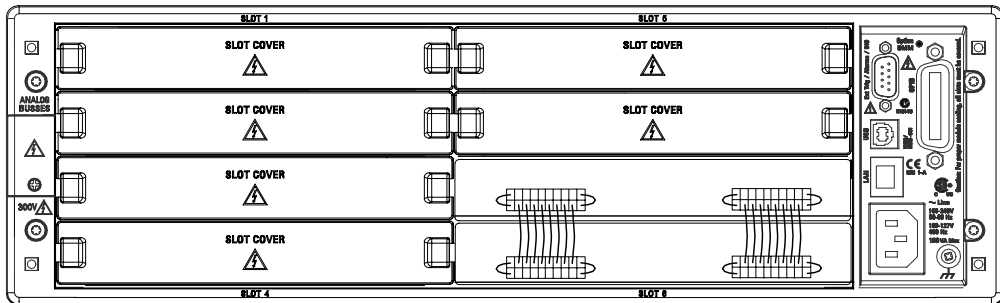

Alternate method of connecting two 34934A modules.
 Example: base configuration for each is 8x64; resulting expanded-row matrix is 8x128.

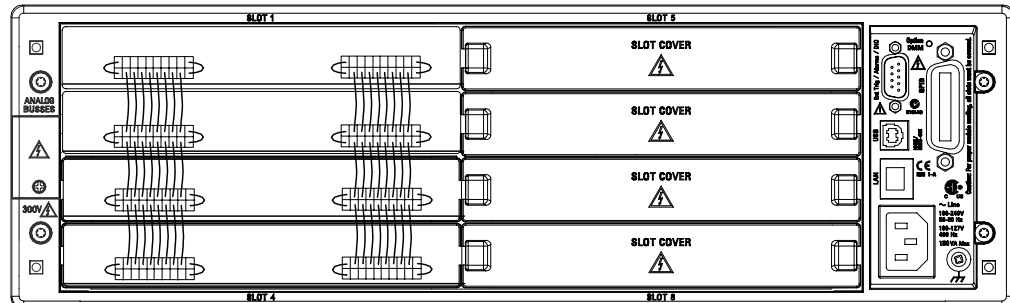

Four 34934A modules (with attached terminal blocks) connected in an extended-row configuration.
 Example: base configuration for each is 16x32; resulting expanded-row matrix is 16x128.

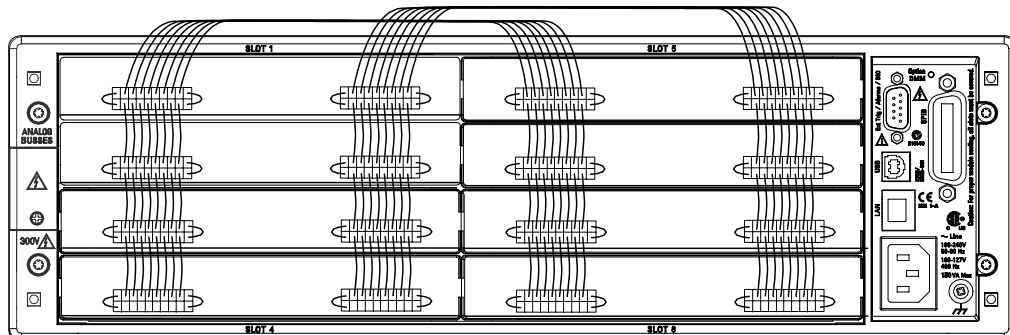

Eight 34934A modules (with attached terminal blocks) connected in an extended-row configuration.
 Example: base configuration for each is 8x64; resulting expanded-row matrix is 8x512.

In the previous examples, note the module interconnection wires (illustrated from the rear view) which link the terminal blocks.

Typically, you would connect the upper row of the extension connector on a lower block to the lower row of the block above it, as shown in the detail at right (side view of terminal blocks and headers).

For convenience, Agilent sells (available separately) a 34934-80003 Expansion Cable Kit, which includes pre-wired terminators (sold in pairs) you would use to replace all but the bottom-most of the supplied terminators in the daisy-chain illustrated at right.

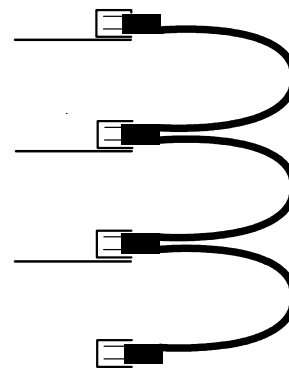

The Expansion Cable (pictured below) has eight 20 AWG wires pre-connected to the lower row (even pins 4-18) of an expansion terminator. The eight wires connect to the upper row (odd pins 3-17) of the next-lower 34934C-001 in the mainframe.



Four modules can be interconnected on each side of the mainframe in this manner, using three expansion cables. Should you need to make the last connection (between the two upper or lower modules) for an eight-module expanded matrix, you would have to fabricate the interconnection using eight 22 AWG coated wires, fitted to “crimp-to-wire” contacts with latch tabs (FCI part #76357-301LF or equivalent).

Arranging Multiple 34934A Modules with Configuration Blocks

The illustrations below show just a few of the possible physical installations of multiple 34934A-34934C pairs in a 34980A mainframe.

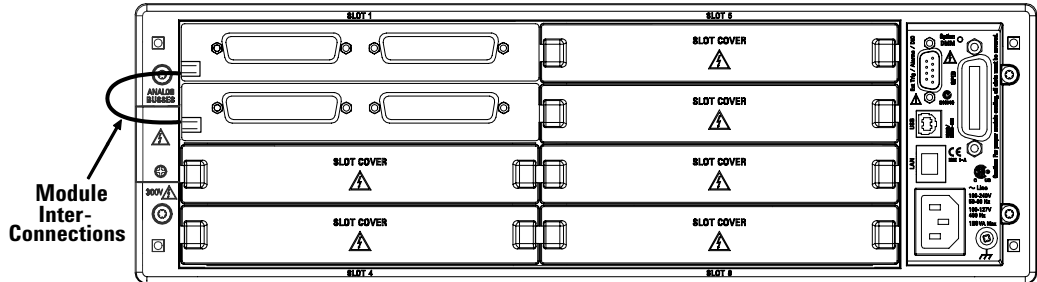

Two 34934A modules (with attached configuration blocks) connected in an extended-row configuration. Example: base configuration for each is 4x128; resulting expanded-row matrix is 4x256.

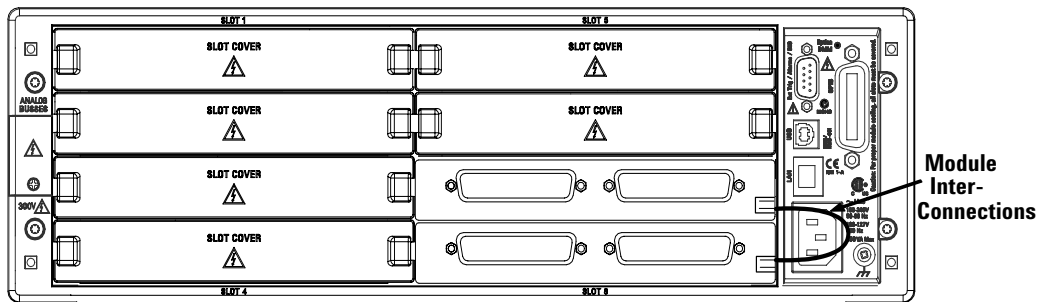

Alternate method of connecting two 34934A modules. Example: base configuration for each is 8x64; resulting expanded-row matrix is 8x128.

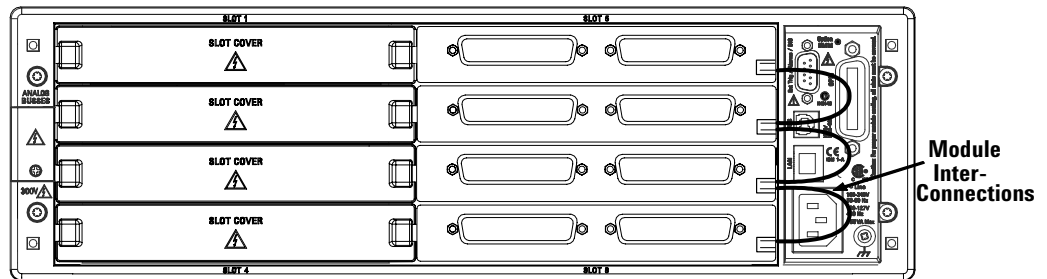

Four 34934A modules (with attached configuration blocks) connected in an extended-row configuration. Example: base configuration for each is 16x32; resulting expanded-row matrix is 16x128.

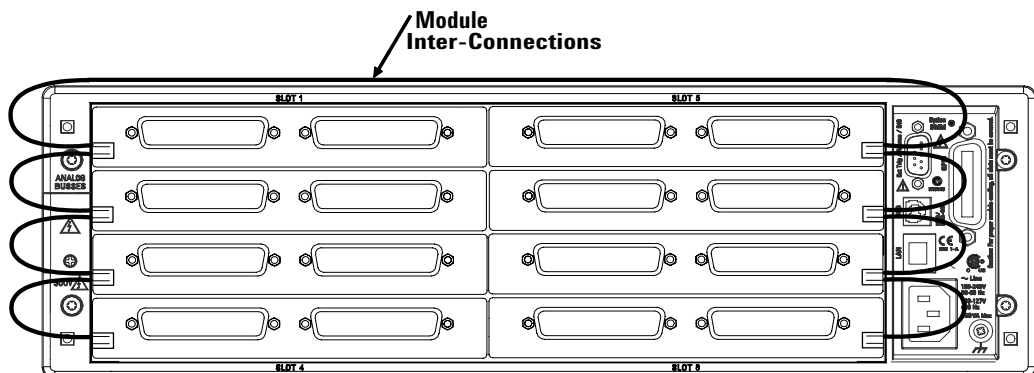

Eight 34934A modules (with attached configuration blocks) connected in an extended-row configuration. Example: base configuration for each is 8x64; resulting expanded-row matrix is 8x512.

In the previous examples, note the module interconnection wires (illustrated from the side view) which link the configuration blocks. From a side view, although there are *two* extension connectors on each side edge (left and right) of each configuration block; only one is shown.

Typically, you would connect the upper row of the extension connector on a lower block to the lower row of the block above it, as shown in the detail at right.

For convenience, Agilent sells (available separately) a 34934-80003 Expansion Cable Kit, which includes pre-wired terminators (sold in pairs) you would use to replace all but the bottom-most of the supplied terminators in the daisy-chain illustrated at right.

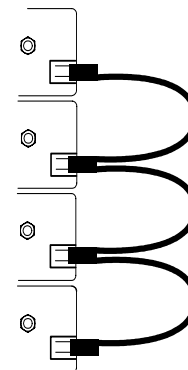

The Expansion Cable (pictured below) has eight 20 AWG wires pre-connected to the lower row (even pins 4-18) of an expansion terminator. The eight wires connect to the upper row (odd pins 3-17) of the next-lower 34934C-001 in the mainframe.



Four modules can be interconnected on each side of the mainframe in this manner, using three expansion cables. Should you need to make the last connection (between the two upper or lower modules) for an eight-module expanded matrix, you would have to fabricate the interconnection using eight 22 AWG coated wires, fitted to “crimp-to-wire” contacts with latch tabs (FCI part #76357-301LF or equivalent).

Creating Expanded-Row Matrices Using Terminal Blocks

Four-row matrices use the 34934T-001 terminal block. Eight-row or sixteen-row matrices use the 34934T-002 terminal block.

Your large matrix will be built as multiples of a base configuration of 4x32, 4x64, 4x128, 8x32, 8x64 or 16x32. Thus, please thoroughly read the appropriate base configuration section in [Chapter 2](#), “Base Matrix Configuration”, before combining modules and these terminal blocks to create multiples of your base matrix.

The illustration below shows expansion header locations on the 34934T-001 terminal block; the expansion header layout for the 34934T-002 is the same.

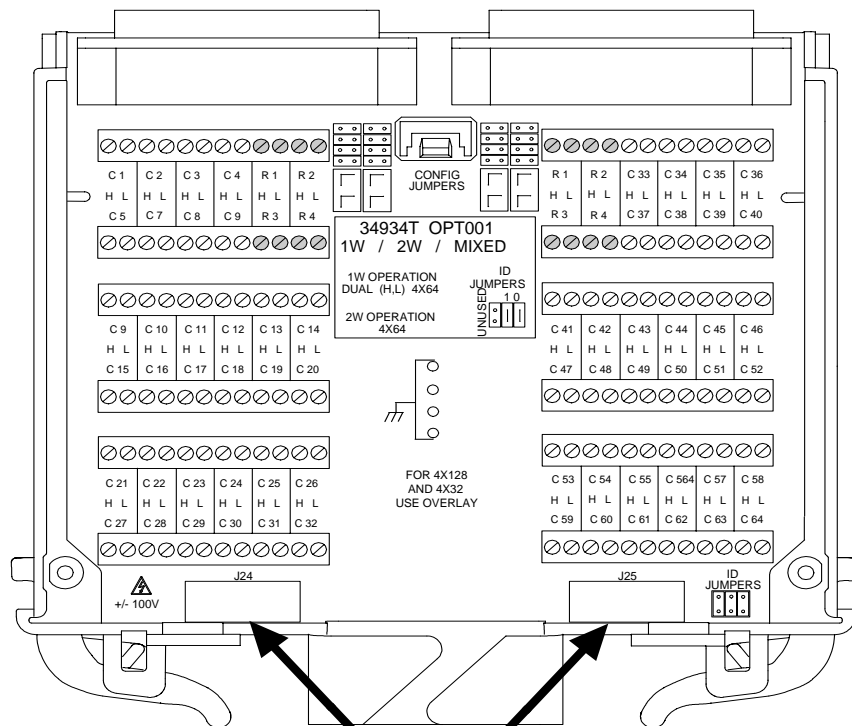

4x32, 8x32, 8x64 and 16x32 expand using both J24 and J25

4x64 and 4x128 expand using only J24

The next section shows how to make connections linking the modules through the expansion headers.

Interconnecting Terminal Blocks

At the rear of each terminal block are a pair of 20-pin extension headers, J24 and J25. These headers provide for row extension and row signal access.

If your base configuration is 4x64 or 4x128, you need create only *one* module interconnection chain, linking all J24 connectors.

For all other base configurations, you must connect create *two* module interconnection chains; one linking all J24 connectors, the other linking all J25 connectors.

For each interconnection chain, to physically link the member modules in an expanded-row matrix, you must connect the center eight pins either pins 3-17 (top row) or pins 4-18 (bottom row) of the corresponding (J214 or J25) extension headers on each terminal block in the matrix. An example of a daisy-chain connection of a four-module matrix is shown below.

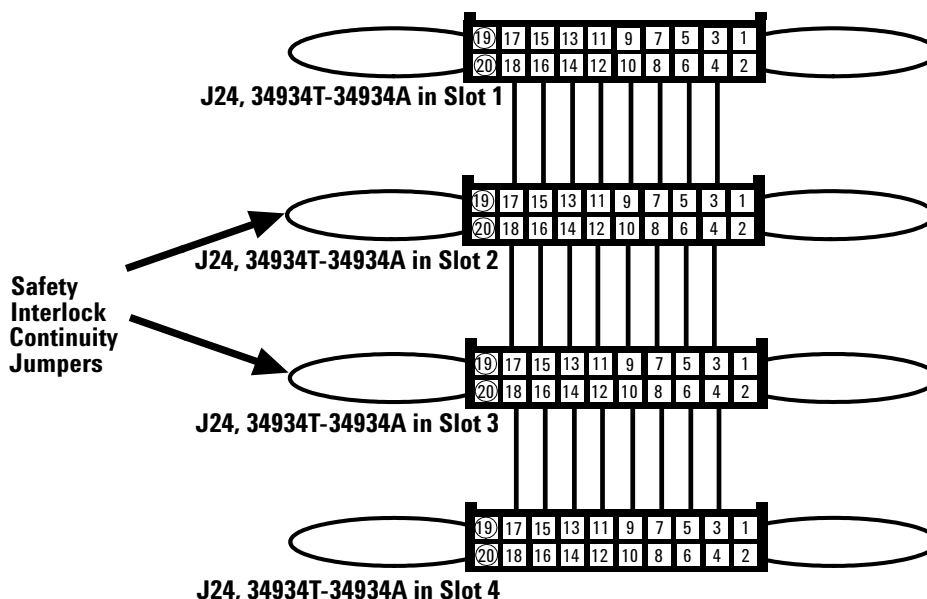

For convenience, Agilent sells an optional 34934-80003 Expansion Cable Kit, which includes two Matrix Expansion Cables (these are like the supplied terminators, but with eight additional wires). There are two per kit for modes in which you will need two cables per T-block to build the daisy-chain. On page 161 is an illustration of the Expansion Cable which comes in the optional kit, and associated wiring instructions.

Keep the bottom-most supplied terminator in a chain intact; then use an Expansion Cable to connect to the T-block above it. Add an Expansion Cable per additional T-block in the daisy chain.

Creating Expanded-Row Matrices Using Configuration Blocks

Four-row matrices use the 34934C-001 configuration block. Eight-row or sixteen-row matrices use the 34934C-002 configuration block.

Your large matrix will be built as multiples of a base configuration of 4x32, 4x64, 4x128, 8x32, 8x64 or 16x32. Thus, please thoroughly read the appropriate base configuration section in [Chapter 2](#), “Base Matrix Configuration”, before combining modules and these configuration blocks to create multiples of your base matrix.

In [Chapter 2](#), you placed jumpers on each configuration block which determined *which expansion headers are available for module interconnection*.

The illustration below shows expansion header locations on the 34934C-001 configuration block; the expansion header layout for the 34934C-002 is the same.

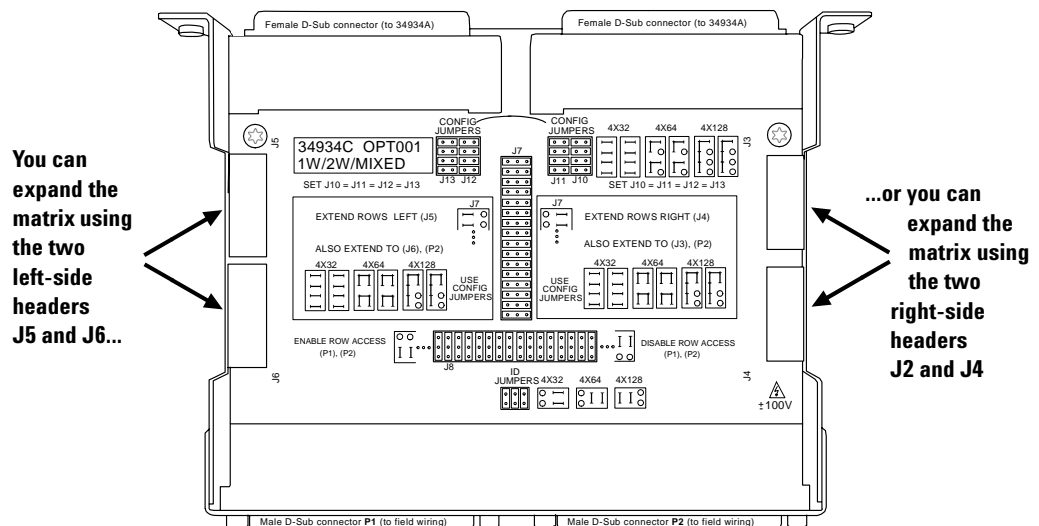

The next section shows how to make connections linking the modules through the expansion headers.

Interconnecting Configuration Blocks

At each side of each configuration block are a pair of 20-pin extension headers. On the right side are labeled J3 and J4; on the left side are J5 and J6. These headers provide for row extension and row signal access, depending on the placement of the block’s J7 jumpers. You must have set the jumpers to extend rows to at least one of the four extension headers—possibly two. We’ll call these the “live” headers.

If your base configuration is 4x64 or 4x128, you need create only *one* module interconnection chain, linking all J5 connectors (if expanding left) or linking all J4 connectors (if expanding right). If you set the J7 jumpers to also make the J3 or J6 headers live on *all* blocks in the matrix, you can alternately create this chain by linking all J3 or all J6 connectors.

For all other base configurations, you must connect create *two* module interconnection chains; one linking all J5 connectors *and* one linking all J6 connectors (if expanding left); one linking all J3 connectors *and* one linking all J4 connectors (if expanding right).

For each interconnection chain, to physically link the member modules in an expanded-row matrix, you must connect the center eight pins either pins 3-17 (top row) or pins 4-18 (bottom row) of the corresponding (J214 or J25) extension headers on each terminal block in the matrix. An example of *one column* of a daisy-chain connection of a four-module matrix is shown below.

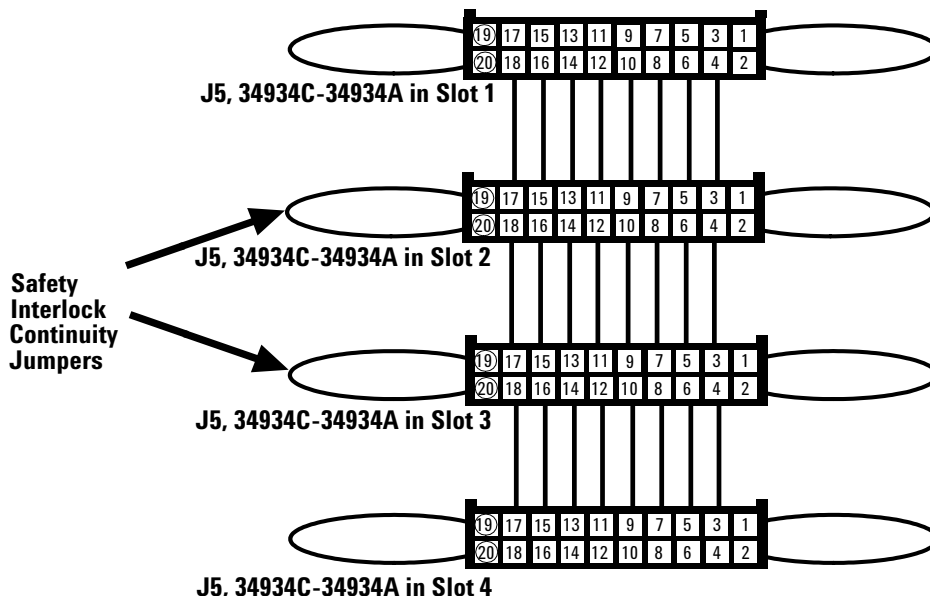

For convenience, Agilent sells an optional 34934-80003 Expansion Cable Kit, which includes two Matrix Expansion Cables (these are like the supplied terminators, but with eight additional wires). There are two per kit for modes in which you will need two cables per C-block to build the daisy-chain. On [page 161](#) is an illustration of the Expansion Cable which comes in the optional kit, and associated wiring instructions.

Keep the bottom-most supplied terminator in a chain intact; then use an Expansion Cable to connect to the C-block above it. Add an Expansion Cable per additional C-block in the daisy chain.



4 SCPI Programming

This chapter provides two main sections.

The first provides the channel numbering algorithm for all configurations of the 34934A matrix module.

The second presents a summary of the programming commands you can send to the 34980A to operate and query status of the 34934A module. For the more frequently used commands, a description and examples are provided.

This chapter is not intended to be an exhaustive reference to these commands; you are encouraged to consult the *Agilent 34980A Programmer's Reference* for complete command syntax and applicability rules.

Channel Numbering [168](#)

SCPI Commands Used by the 34934A [169](#)

Command Summary [169](#)

Opening and Closing Channels [170](#)

Querying Channels for Open or Closed State [171](#)

Querying the Mainframe for Module Identity [172](#)

Setting the Relay Protection Mode [172](#)

Reading Relay Cycle Count [172](#)



Channel Numbering

The slot and channel addressing scheme used in the programming examples follow the general form **sxxx** where **s** is the slot number for the 34980A mainframe (1 through 8) and **xxx** is the three-digit channel number. Channel numbers for the matrix modules are derived as shown in the following table:

34934A Module Channel Numbering		
Each row,column intersection has a unique channel number. This 4- digit channel number is of the form sxxx , where s is the mainframe slot# for the 34934A module. Calculate xxx from row R and column C , as shown below		
4x32 (4 matrices)	for M1H:	$xxx = 100(2R-1) + C$
	for M2H:	$xxx = 100(2R-1) + C + 32$
	for M1L:	$xxx = 100(2R-1) + C + 64$
	for M2L:	$xxx = 100(2R-1) + C + 96$
4x64 (2 matrices)	for MH:	$xxx = 100(2R-1) + C$
	for ML:	$xxx = 100(2R-1) + C + 64$
4x128	$xxx = 100(2R-1) + C$	
8x32 (2 matrices)	for MH:	$xxx = 100R + C$
	for ML:	$xxx = 100R + C + 32$
8x64	$xxx = 100R + C$	
16x32	$xxx = 50(R+1) + C$	
Examples:		
in slot #1, 8x64 matrix, you need to address row 3, column 16 Then $xxx = 100(3) + 16 = 316$, so the channel # is 1316		

in slot #2, 4x32 matrix M2H, you need to address row 4, column 21 Then $xxx = 100(2 \times 4 - 1) + 21 + 32 = 753$, so the channel # is 2753		

The 34980A Web Browser interface, offers the easiest method to view the channel map for any set configuration of the module.

For complete guidance on LAN connection and navigating the 34980A Web Browser Interface, see the “Getting Started” chapter of the 34980A Mainframe Users Guide.

SCPI Commands Used by the 34934A

Command Summary

The commands listed below are used to control and query the operational state of the 34934A. Not listed are commands which apply to all 34980A modules.

Subsystem	Commands
DIAGnostic	DIAGnostic:RElAy:CYCLes? (@<ch_list>) DIAGnostic:RElAy:CYCLes:CLear (@<ch_list>)
ROUTE	ROUTe:CLOSe (@<ch_list>) ROUTe:CLOSe? (@<ch_list>) ROUTe:CLOSe:EXCLusive (@<ch_list>) ROUTe:CLOSe:PAIR (@<ch_list>) ROUTe:CLOSe:PAIR? (@<ch_list>) ROUTe:MODule:BUSY? {slot ANY} ROUTe:MODule:WAIT <slot ALL> ROUTe:MODule:WAIT? <slot ALL> ROUTe:OPEN (@<ch_list>) ROUTe:OPEN? (@<ch_list>) ROUTe:OPEN:ALL [{<slot> ALL}] ROUTe:OPEN:PAIR (@<ch_list>) ROUTe:OPEN:PAIR? (@<ch_list>) ROUTe:OPERation:OVERlap[:ENABLE] <mode> ROUTe:OPERation:OVERlap[:ENABLE]?
System - Related Commands	SYSTEM:MODule:ROW:PROTection <slot>, <mode> SYSTEM:MODule:ROW:PROTection? <slot> SYSTEM:MODule:ROW:PROTection DEFault, <mode> SYSTEM:MODule:ROW:PROTection? DEFault SYSTEM:MODule:TERMinal:TYPE? <slot>

In the following subsections are examples which highlight *some* of the more commonly used commands listed above.

For complete command syntax, related information and examples of these and other SCPI commands used to program the 34980A, refer to the *Agilent 34980A Programmer's Reference* contained on the *34980A Product Reference CD*.

Opening and Closing Channels

No physical matrix configuration changes are required for 1-wire versus 2-wire operation. The SCPI commands alone determine if channels on paired matrices are closed individually or in pairs. Therefore, individual 1-wire and 2-wire commands can be combined in a program sequence.

One Wire Operation

The ROUTe:CLOSe and ROUTE:OPEN commands close and open a single one-wire channel or list of one-wire channels.

Example 1: The example below opens a single crosspoint at row 3, column 1, matrix M1L; with the module in Slot 1 and configured for 4x32 mode.

```
ROUT:OPEN (@1565)
```

Example 2: The example below closes a path containing two crosspoints. They are at row 2, columns 2 and 34, matrix MH; with the module in Slot 2 and configured for 4x64 mode.

```
ROUT:CLOS (@1302,1334)
```

Two Wire Operation

The ROUTe:CLOSe:PAIR and ROUTE:OPEN:PAIR commands close and open a single two-wire channel pair or list of two-wire channel pairs. They apply only to the following matrix modes, and operate channels in the listed paired matrices:

- 4x32: Paired matrices M1H and M1L; Paired matrices M2H and M2L
- 4x64: Paired matrices MH and ML
- 8x32: Paired matrices MH and ML

Example 1: The example below opens a single paired crosspoint at row 3, column 1, matrices M1H and M1L; with the module in Slot 1 and configured for 4x32 mode.

```
ROUT:OPEN:PAIR (@1565)
```

Note the similarity in syntax to the 1-wire command; *in any paired command, you specify only the high channel in the pair*. However, this command not only opens channel 1565 on M1H, but also automatically opens paired channel 1629 on M1L.

Example 2: The example below closes a 2-wire path containing four crosspoints (two pairs of channels). The crosspoints are row 2, columns 2 and 34, matrices MH and ML; with the module in Slot 2 and configured for 4x64 mode.

```
ROUT:CLOS:PAIR (@1302, 1334)
```

Note the similarity in syntax to the 1-wire command. However, this command not only opens channels 1302 and 1334 on M1H, but also automatically opens paired channels 1366 and 1400 on M1L.

Querying Channels for Open or Closed State

One Wire Operation

The ROUTe:CLOSe? and ROUTe:OPEN? commands query the state of a single one-wire channel or list of one-wire channels. It returns (for each channel in the list) a “1” (true) if the channel is closed or a “0” (false) if the channel is open.

Example: The example below closes the crosspoint at row 4, column 2, matrix MH; with the module in Slot 5 and configured for 8x32 mode. Then two queries are sent, with the expected results.

```
ROUT:CLOS (@5402)
ROUT:CLOS? (@5402) !Returns a 1
ROUT:OPEN? (@5402) !Returns a 0
```

Two Wire Operation

The ROUTe:CLOSe:PAIR? and ROUTe:OPEN:PAIR? commands query the state of a single two-wire channel pair or list of two-wire channel pairs. They apply only to the following matrix modes, and operate channels in the listed paired matrices:

- 4x32: Paired matrices M1H and M1L; Paired matrices M2H and M2L
- 4x64: Paired matrices MH and ML
- 8x32: Paired matrices MH and ML

Example: The example below closes the channel pair at row 3, column 2, matrices MH and ML; with the module in Slot 5 and configured for 8x32 mode. Then two queries are sent, with the expected results.

```
ROUT:CLOS:PAIR (@5402)
ROUT:CLOS:PAIR? (@5402) !Returns a 1
ROUT:OPEN:PAIR? (@5402) !Returns a 0
```

Note the similarity in syntax to the 1-wire command; *in any paired command, you specify only the high channel in the pair.* However, this command returns (for each channel pair in the list) a “1” if both relays are closed; it returns a “0” if either or both relays are open.

Querying the Mainframe for Module Identity

The `SYSTEM:MODule:TERMinal:TYPE?` command queries the 34980A mainframe for the recognized base configuration “ID” for the 34934A module in a specified slot. The mainframe sees this ID upon bootup, whether the ID was set by direct D-Sub wiring, terminal block jumper placement or configuration block jumper placement.

Example: The following command returns the identity of the 34934A module installed in slot 7, if set for a base configuration of 16x32. The result does not depend on whether this module is a stand-alone matrix or used as a member of an extended-row matrix configuration.

```
SYST:MOD:TERM:TYPE? 7 !Returns R16_C32
```

Setting the Relay Protection Mode

The `SYSTEM:MODule:ROW:PROTection` command sets the row protection mode for the 34934A module in a specified slot.

Example: The following command sets the row protection mode to `FIXed`, which closes the row protection relays on all rows for the 34934A module in slot 7.

```
SYST:MOD:ROW:PROT 7, FIX
```

Example: The following command sets the *default* row protection mode to `ISOLated`, which opens the row protection relays and bypass relays on all rows for all 34934A modules in the mainframe. The command is executed at power-on or following a `*RST` or `SYSTEM:CPON` command.

```
SYST:MOD:ROW:PROT DEF, ISO
```

Reading Relay Cycle Count

The `DIAGnostic:RELay:CYCLes?` command queries the cumulative number of operational cycles (relay cycle count) for any of the 512 crosspoint relays in the 34934A module, since it was last reset. The query can be used for a single channel or list of channels.

Example: The following command returns the cycle count at row 8, column 28, with the module in Slot 4 and configured for 8x64 mode.

```
DIAG:REL:CYCL? (@4831)
```

Index

Numerics

- 16x32
 - matrix configuration, [132](#)
 - matrix topology, [26](#)
 - test circuit example, [27](#)
 - wire jumpers for 34934T-002, [137](#)
- 34934A Module
 - D-Sub pin assignments for 16x32, [151](#)
 - D-Sub pin assignments for 4x128, [87](#)
 - D-Sub pin assignments for 4x32, [47](#)
 - D-Sub pin assignments for 4x64, [67](#)
 - D-Sub pin assignments for 8x32, [108](#)
 - D-Sub pin assignments for 8x64, [129](#)
 - D-Sub wiring for 16x32, [151, 152](#)
 - D-Sub wiring for 4x128, [87, 88](#)
 - D-Sub wiring for 4x32, [47, 48](#)
 - D-Sub wiring for 4x64, [67, 68](#)
 - D-Sub wiring for 8x32, [108, 109](#)
 - D-Sub wiring for 8x64, [129, 130](#)
- 34934C-001 Configuration Block
 - configuration block interconnection, [165](#)
 - D-Sub pin assignments for 4x128, [85](#)
 - D-Sub pin assignments for 4x32, [45](#)
 - D-Sub pin assignments for 4x64, [65](#)
 - D-Sub wiring for 4x128, [85](#)
 - D-Sub wiring for 4x32, [45](#)
 - D-Sub wiring for 4x64, [65](#)
 - extension header pin assignments for 4x128, [84](#)
 - extension header pin assignments for 4x32, [44](#)
 - extension header pin assignments for 4x64, [64](#)
 - jumper types, [38, 57, 77, 98, 119, 141](#)
 - layout, [37, 56, 76](#)
 - placing CONFIG jumpers for 4x128, [79](#)
 - placing CONFIG jumpers for 4x32, [39](#)
 - placing CONFIG jumpers for 4x64, [59](#)
 - placing ID jumpers for 4x128, [78](#)
 - placing ID jumpers for 4x32, [39](#)
 - placing ID jumpers for 4x64, [58](#)
 - placing row access jumpers, [41, 61, 81](#)
 - placing row extension jumpers, [40, 60, 80](#)
 - placing safety interlock continuity jumpers, [42, 62, 82](#)
 - row wiring options, [43, 63, 83](#)
 - wiring, [43, 63, 83](#)
- 34934C-001 Terminal Block
 - terminal block interconnection, [163](#)
- 34934C-002 Configuration Block
 - configuration block interconnection, [165](#)
 - D-Sub pin assignments for 16x32, [149](#)
 - D-Sub pin assignments for 8x32, [106](#)
 - D-Sub pin assignments for 8x64, [127](#)
 - D-Sub wiring for 16x32, [149](#)
 - D-Sub wiring for 8x32, [106](#)
 - D-Sub wiring for 8x64, [127](#)
- extension header pin assignments for 16x32, [148](#)
- extension header pin assignments for 8x32, [105](#)
- extension header pin assignments for 8x64, [117, 126](#)
- layout, [97, 118, 140](#)
- placing CONFIG jumpers for 16x32, [142](#)
- placing CONFIG jumpers for 8x32, [99](#)
- placing CONFIG jumpers for 8x64, [120](#)
- placing ID jumpers for 16x32, [142](#)
- placing ID jumpers for 8x32, [99](#)
- placing ID jumpers for 8x64, [120](#)
- placing row access jumpers, [101, 122, 144](#)
- placing row extension jumpers, [100, 121, 143](#)
- placing row setting jumpers, [102, 123, 145](#)
- placing safety interlock continuity jumpers, [103, 124, 146](#)
- row wiring options, [104, 125, 147](#)
- wiring, [104, 125, 147](#)
- 34934T-001 Terminal Block
 - configuring for 4x128, [72](#)
 - configuring for 4x32, [33](#)
 - configuring for 4x64, [52](#)
 - extension header pin assignments for 4x128, [75](#)
 - extension header pin assignments for 4x32, [36](#)
 - extension header pin assignments for 4x64, [55](#)
 - extension header wiring for 4x128, [75](#)
 - extension header wiring for 4x32, [36](#)
 - extension header wiring for 4x64, [55](#)
 - layout for 4x128, [70](#)
 - layout for 4x32, [31](#)
 - layout for 4x64, [50](#)
 - placing CONFIG jumpers for 4x128, [72](#)
 - placing CONFIG jumpers for 4x32, [33](#)
 - placing CONFIG jumpers for 4x64, [52](#)
 - placing ID jumpers for 4x128, [73](#)
 - placing ID jumpers for 4x32, [34](#)
 - placing ID jumpers for 4x64, [53](#)
 - placing Safety Interlock Continuity jumpers for 4x128, [73](#)
 - placing Safety Interlock Continuity jumpers for 4x32, [34](#)
 - placing Safety Interlock Continuity jumpers for 4x64, [53](#)
 - row wiring options for 4x128, [74](#)
 - row wiring options for 4x32, [35](#)
 - row wiring options for 4x64, [54](#)
 - wiring for 4x128, [74](#)
 - wiring for 4x32, [35](#)
 - wiring for 4x64, [54](#)
- 34934T-002 Terminal Block
 - 8x64 layout, [112](#)
 - configuring for 16x32, [135](#)
 - configuring for 8x32, [92](#)
 - configuring for 8x64, [114](#)
 - extension header pin assignments for 16x32, [139](#)
 - extension header pin assignments for 8x32, [96](#)
 - extension header wiring for 16x32, [139](#)
 - extension header wiring for 8x32, [96](#)
 - extension header wiring for 8x64, [117](#)
 - layout for 16x32, [133](#)
 - layout for 8x32, [90](#)
 - placing CONFIG jumpers for 16x32, [135](#)
 - placing CONFIG jumpers for 8x32, [93](#)
 - placing CONFIG jumpers for 8x64, [114](#)
 - placing ID jumpers for 16x32, [136](#)
 - placing ID jumpers for 8x32, [94](#)
 - placing ID jumpers for 8x64, [115](#)
 - placing Safety Interlock Continuity jumpers for 16x32, [136](#)
 - placing Safety Interlock Continuity jumpers for 8x32, [94](#)
 - placing Safety Interlock Continuity jumpers for 8x64, [115](#)
 - row wiring options for 8x32, [95](#)
 - row wiring options for 8x64, [116](#)
 - terminal block interconnection, [163](#)
 - terminal wiring options for 16x32, [137](#)
 - terminal wiring options for 8x32, [91](#)
 - terminal wiring options for 8x64, [113](#)
 - wire jumpers for 16x32, [137](#)
 - wiring for 8x32, [95](#)
 - wiring for 8x64, [116](#)
- 34980A Web Browser Interface, [8, 11](#)
- 4x128
 - matrix configuration, [69](#)
 - matrix topology, [19](#)
 - test circuit example, [20](#)
- 4x32
 - matrix configuration, [30](#)
 - matrix topology, [13](#)
 - test circuit examples, [14, 15](#)
- 4x64
 - matrix configuration, [49](#)
 - matrix topology, [16](#)
 - test circuit examples, [17, 18](#)
- 8x32
 - matrix configuration, [89](#)
 - test circuit examples, [22, 23](#)
- 8x64
 - matrix configuration, [111](#)
 - matrix topology, [21, 24](#)
 - test circuit example, [25](#)

A

analog bus connections, [4](#)

Index

B

basic module configuration steps, 6

C

channel numbering, 168
closing channels, 170
connecting modules in an expanded matrix, 163, 165

D

D-Sub connectors
34934A pin assignments for 16x32, 151
34934A pin assignments for 4x128, 87
34934A pin assignments for 4x32, 47
34934A pin assignments for 4x64, 67
34934A pin assignments for 8x32, 108
34934A pin assignments for 8x64, 129
34934A wiring for 16x32, 151, 152
34934A wiring for 4x128, 87, 88
34934A wiring for 4x32, 47, 48
34934A wiring for 4x64, 67, 68
34934A wiring for 8x32, 108, 109
34934A wiring for 8x64, 129, 130
34934C-001 pin assignments for 4x128, 85
34934C-001 pin assignments for 4x32, 45
34934C-001 pin assignments for 4x64, 65
34934C-001 safety interlock continuity wiring for 4x128, 86
34934C-001 safety interlock continuity wiring for 4x32, 46
34934C-001 safety interlock continuity wiring for 4x64, 66
34934C-001 wiring for 4x128, 85
34934C-001 wiring for 4x32, 45
34934C-001 wiring for 4x64, 65
34934C-002 pin assignments for 16x32, 149
34934C-002 pin assignments for 8x32, 106
34934C-002 pin assignments for 8x64, 127
34934C-002 safety interlock continuity wiring for 8x32, 107, 150
34934C-002 safety interlock continuity wiring for 8x64, 128
34934C-002 wiring for 16x32, 149
34934C-002 wiring for 8x32, 106
34934C-002 wiring for 8x64, 127

E

electrical considerations, 3
extension headers
pin assignments for 16x32, 139, 148
pin assignments for 4x128, 75, 84
pin assignments for 4x32, 36, 44
pin assignments for 4x64, 55, 64
pin assignments for 8x32, 96, 105
pin assignments for 8x64, 117, 126

L

linking multiple matrix modules, 156

M

matrix configuration
16x32, 132
4x128, 69
4x32, 30
4x64, 49
8x32, 89
8x64, 111
module queries
channel open or closed state, 171
configuration ID, 172

O

opening channels, 170
operating considerations, 3

P

programming examples, 168

R

relay closure limits, 3
relay cycle count, 172
relay protection, 5, 172
Auto-0 mode, 5
Auto-100 mode, 5
Fixed mode, 5
Isolated mode, 5
row-protection, 5

S

safety interlock, 3
SCPI command summary, 169
SCPI Commands, 169
series resistors, 5
strain relief, 32, 51, 71, 91, 113, 134

T

terminal block strain relief, 32, 51, 71, 91, 113, 134
thermal considerations, 3

W

warranty, ii
wiring logs, 31, 50, 70, 90, 112, 133